



## GENERAL DESCRIPTION

EM55000 series is a series of 3 to 340 seconds single chip high quality voice synthesizer IC which contains one 4-bit Input port (provided for EM55100 and above), three 4-bit I/O ports and a tiny controller. By programming through the tiny controller, user's application includes section combination, trigger mode, control outputs, keyboard matrix and other logic function can be easily implemented.

## FEATURES

EM55XXX	001	002	100	200	250	300	350	400
Duration(sec)	3		5	10	15	21	31	42
ROM(bits)	10K x 10		16K x 10	32K x 10	48K x 10	64K x 10	96K x 10	128K x 10
PROGRAM ROM (bits)	8K x 10			32K x 10				
RAM (nibbles)	32		64	128				
IO PORTs	4 I/O	8 I/O	4 I+ 8 I/O					
D/A	Traditional DAC	Direct Drive		Direct Drive/Traditional DAC				
OSC	Ring type			Ring or Crystal type by option				
Reset Pin	No			Yes				

EM55XXX	450	451	500	550	551	600	650	700
Duration(sec)	63	63	85	127		170	255	340
ROM(bits)	192K x 10	192K x 10	256K x 10	384K x 10		512K x 10	768K x 10	1024K x 10
PROGRAM ROM (bits)	32K x 10							
RAM (nibbles)	128							
IO PORTs	4 I+ 12 I/O	4 I+ 8 I/O	4 I+ 12 I/O		4 I+ 8 I/O	4 I+ 12 I/O		
D/A	Direct Drive/Traditional DAC							
OSC	Ring or Crystal type by option							
Reset Pin	Yes							

- Single power supply.
- Crystal/Ring oscillator option.
- 3-340 seconds voice capacity.
- Power down mode for saving power consumption.
- Reset pin available.
- Single ROM for voice program. Maximum 32 K program addressing size available.
- Readable ROM data.
- One 6 bit timer overflow control is provided.
- Two stack for subroutine call.
- 5 bits ASPCM synthesis.
- 38K Hz modulation for IR transmission.
- 15 steps volume control.
- Direct Drive/traditional DAC.
- 8 bits resolution D/A.
- Green Voice™.

## PIN DESCRIPTIONS

Symbol	I/O	Function
P1.0	I	Bit 0 of Port 1. (not for EM55001, EM55002)
P1.1	I	Bit 1 of Port 1. (not for EM55001, EM55002)
P1.2	I	Bit 2 of Port 1. (not for EM55001, EM55002)
P1.3	I	Bit 3 of Port 1. (not for EM55001, EM55002)
P2.0	I/O	Bit 0 of Port 2.
P2.1	I/O	Bit 1 of Port 2.
P2.2	I/O	Bit 2 of Port 2. (not for EM55001)
P2.3	I/O	Bit 3 of Port 2. (not for EM55001)
P3.0	I/O	Bit 0 of Port 3. (not for EM55001)
P3.1	I/O	Bit 1 of Port 3. (not for EM55001)
P3.2	I/O	Bit 2 of Port 3. The pin can generate 38KHz square wave.
P3.3	I/O	Bit 3 of Port 3. The pin can be treated as an LED output flashing with volume.
P4.0	I/O	Bit 0 of Port 4. (not for EM55001 ~ EM55400, EM55451, EM55551)
P4.1	I/O	Bit 1 of Port 4. (not for EM55001 ~ EM55400, EM55451, EM55551)
P4.2	I/O	Bit 2 of Port 4. (not for EM55001 ~ EM55400, EM55451, EM55551)
P4.3	I/O	Bit 3 of Port 4. (not for EM55001 ~ EM55400, EM55451, EM55551)
VDD	I	Positive digital power supply.
OSCI	I	Ring oscillator/crystal input pin.
RESET	I	Reset Pin. (not for EM55001, EM55002, EM55100)
OSCO	O	Crystal output pin. (not for EM55001, EM55002, EM55100)
TEST	I	For testing only. (not for EM55001, EM55002)
VSSD	I	Negative digital power supply.
VCC	I	Positive analog power supply. (not for EM55001)
VSSC	I	Negative analog power supply. (not for EM55001)
VO	O	Constant current output / Push Pull voice output.
VO1	O	Push Pull voice output. (not for EM55001)

## ABSOLUTE MAXIMUM RATINGS

Items	Sym.	Min.	Max.	Unit
Supply Voltage	$V_{DD}-V_{SS}$	-0.3	6.0	V
Input Voltage	$V_{IN}$	$V_{SS}-0.3$	$V_{DD}+0.3$	V
Operating Temperature	$T_{OP}$	-20.0	70.0	°C
Storage Temperature	$T_{STG}$	-55.0	+125.0	°C

## ELECTRICAL CHARACTERISTICS (25°C, VDD=3.0 Volts unless otherwise specified)

Parameter	Sym.	Min.	Typ.	Max.	Unit	Condition
Operating voltage	$V_{DD}$	2.2	3.0	5.5	V	
Standby current	$I_{DDS}$	-	-	2.0	μA	$V_{DD}=3V$
Operating current	$I_{DDO}$	-	250	350	μA	$V_{DD}=3V$ , No load, constant current D/A operate
Operating current	$I_{DDO}$	-	2.0	4.0	mA	$V_{DD}=3V$ , No load, push-pull current D/A operate
Drive current of P2,P3,P4	$I_{OD}$	2.0	3.0	-	mA	$V_{DD}=3V$ , $V_o=2.4V$
Sink current of P2 (before KEYB)	$I_{OS}$	-	3.0	10.0	μA	$V_{DD}=3V$ , $V_o=3V$
Sink current of P2(after KEYB)	$I_{OS}$	2.3	3.5	-	mA	$V_{DD}=3V$ , $V_o=0.4V$
Sink current of P3,P4	$I_{OS}$	2.3	3.5	-	mA	$V_{DD}=3V$ , $V_o=0.4V$
Input current of P1	$I_{IH}$	-	3.0	10.0	μA	$V_{DD}=3V$
Output current of VO	$I_{VO}$	4.0	5.2	6.4	mA	$V_{DD}=3V$ , $V_o=0.7V$
		4.0	5.3	6.7	mA	$V_{DD}=4.5V$ , $V_o=0.7V$
Output current of VO,VO1	$I_{VO}$	120	150	-	mA	$V_{DD}=3V$ , $V_o=V_1=0.7V$
Oscillation resistor	R	-	470	-	KΩ	$V_{DD}=3V$ (for EM55001~55100)
			100	-	KΩ	$V_{DD}=3V$ (for EM55200~55700)
Oscillation frequency	$F_{OSC}$	1.08	1.2	1.32	MHz	$V_{DD}=2.2\sim 5.5V$

## APPLICATION CIRCUIT

In the following application circuits:

- 1 : For noisy power supply application, suppress noise by adding ceramic capacitor between VCC and ground near the IC's VDD pad. The recommend capacitor value is  $0.1\mu\text{F}$ .
- 2 : For heavy loading application, it is recommended that an electrolytic capacitor is added between VCC and ground. The recommended capacitor value for button cell applications is  $10\mu\text{F}$ .
- 3 : The recommended value for button cell internal impedance is  $750\Omega$  or less.
- 4 : The use of spring direct trigger is not recommended. If you must use such trigger, you need to add a ceramic capacitor between trigger pin and ground to debounce the spring noise. The recommend capacitor value is  $0.001 \sim 0.01 \mu\text{F}$ .

6-key Application Circuit For EM55001

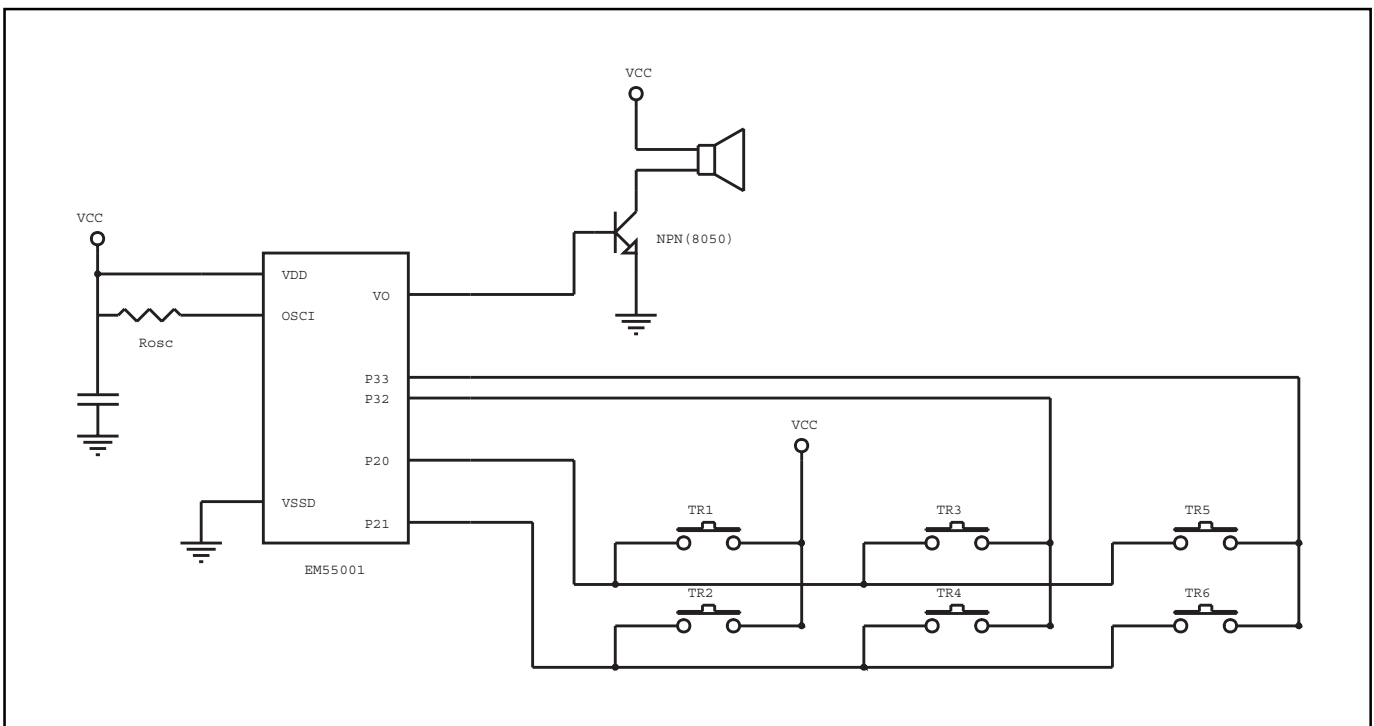

20-key Application Circuit For EM55002

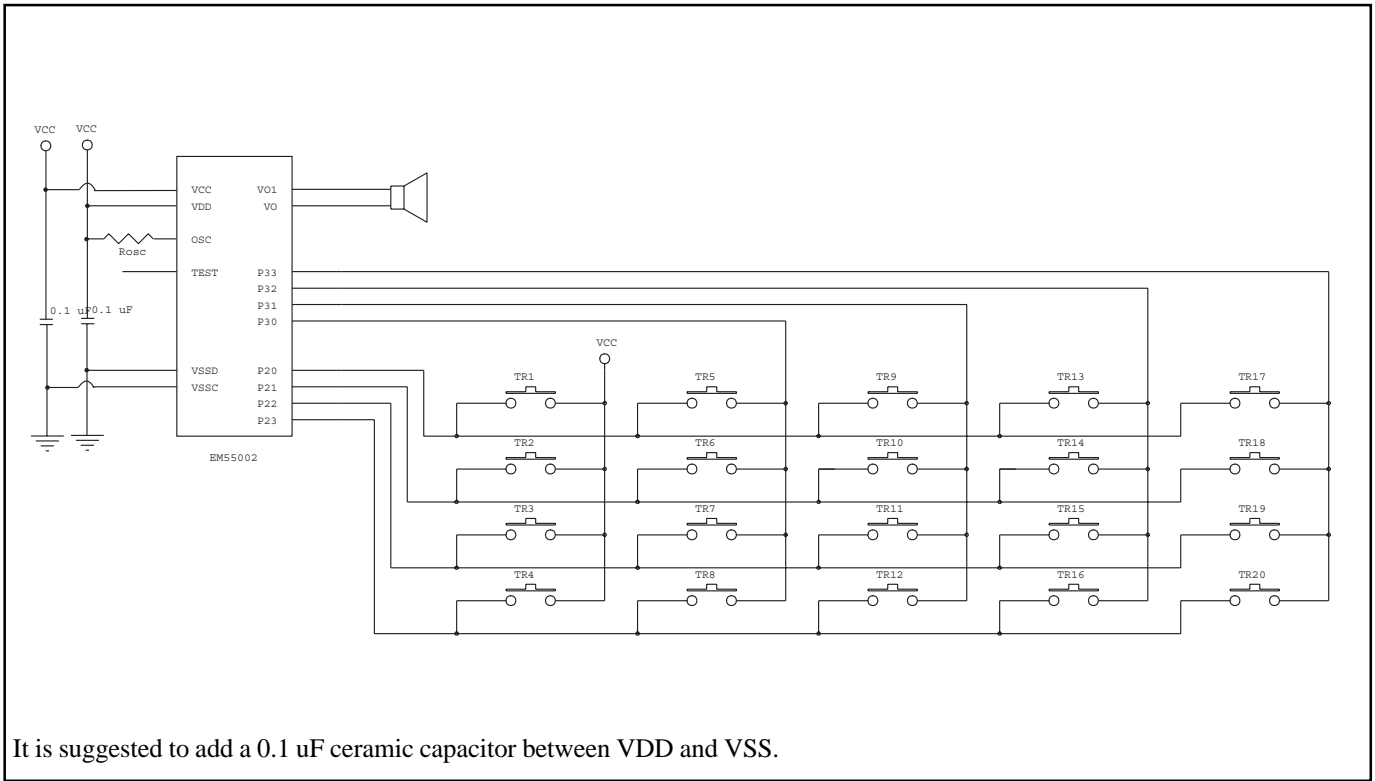

It is suggested to add a 0.1 uF ceramic capacitor between VDD and VSS.

20-key Application Circuit For EM55100~EM55700

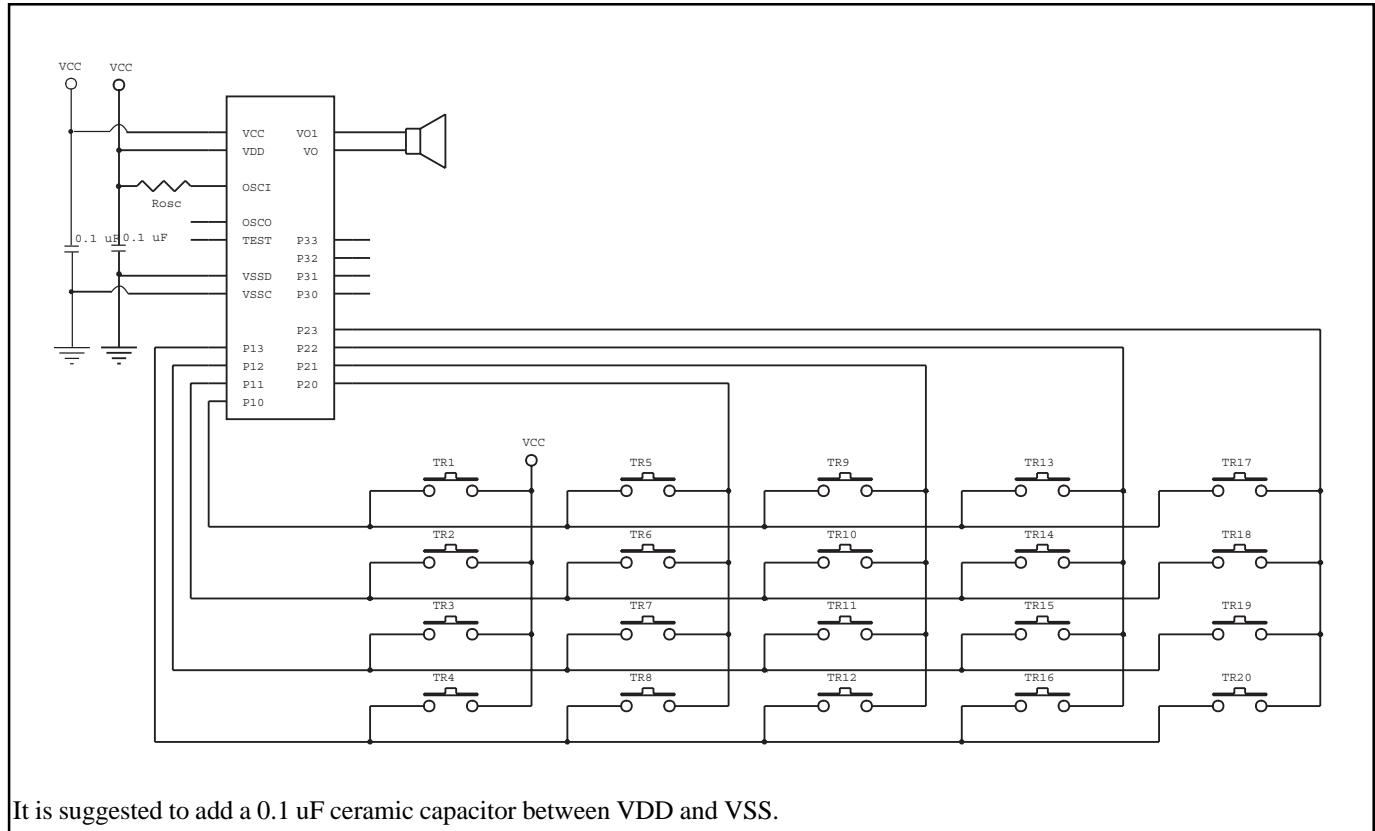

It is suggested to add a 0.1 uF ceramic capacitor between VDD and VSS.

32-key Application Circuit For EM55100~EM55700

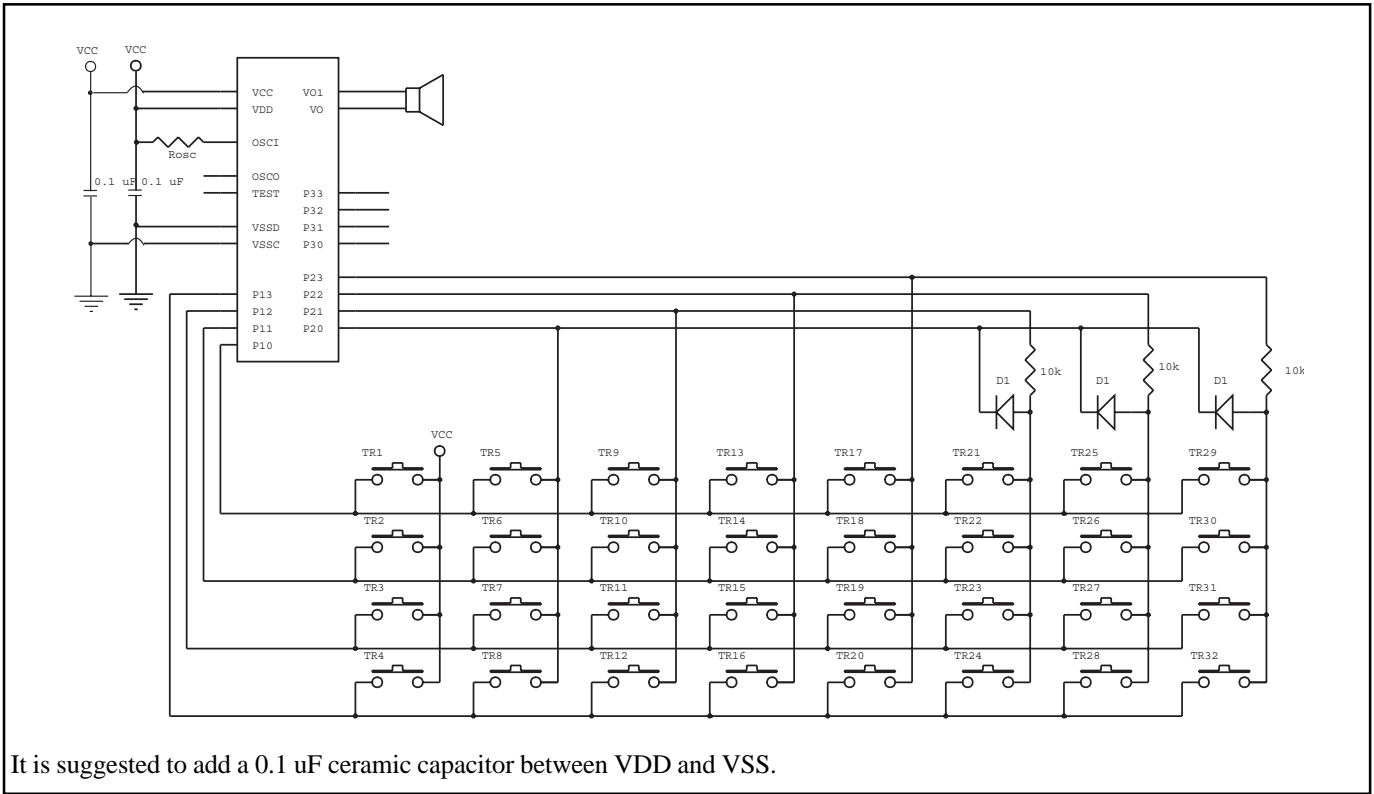

64-key Application Circuit For EM55100~EM55700

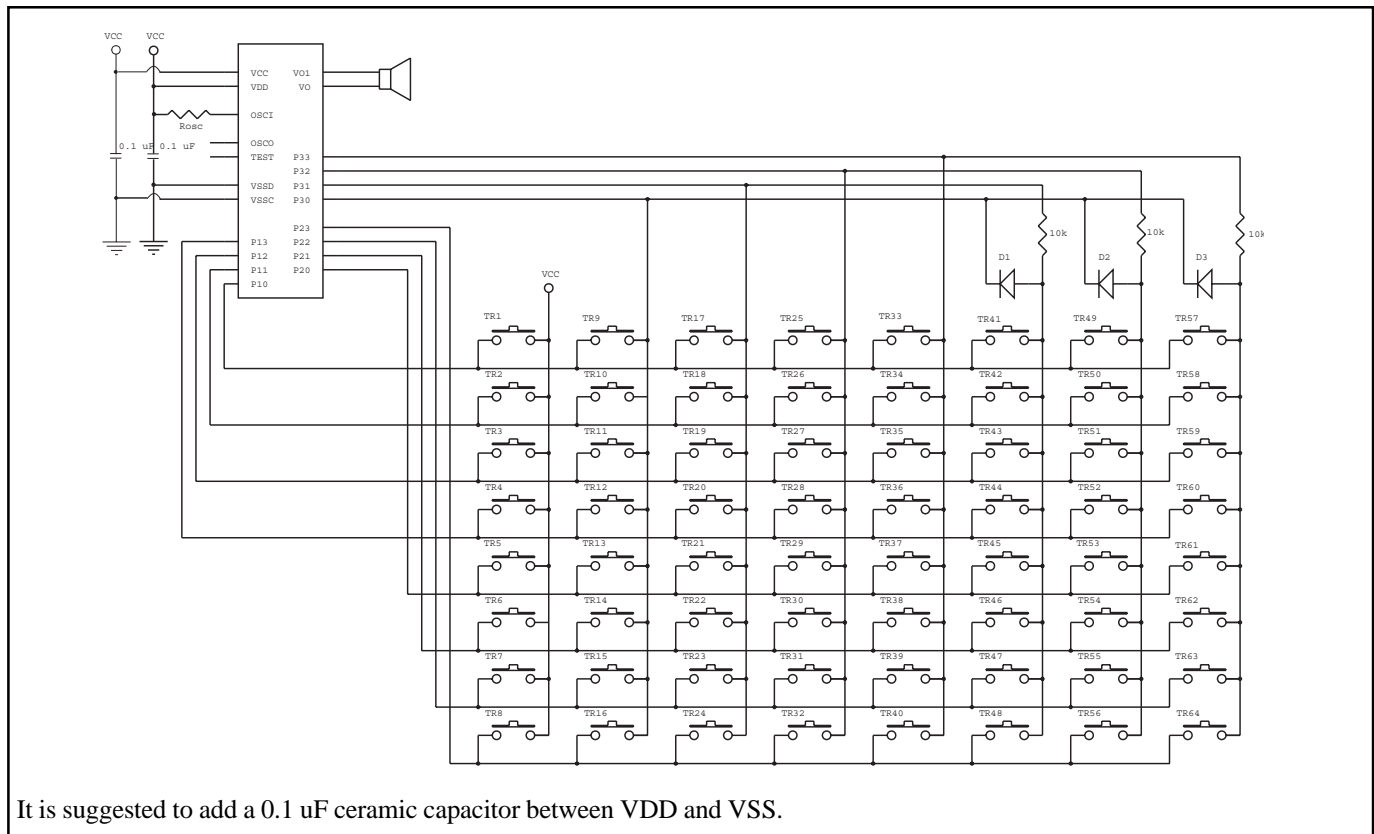

128-key Application Circuit For EM55100~EM55700

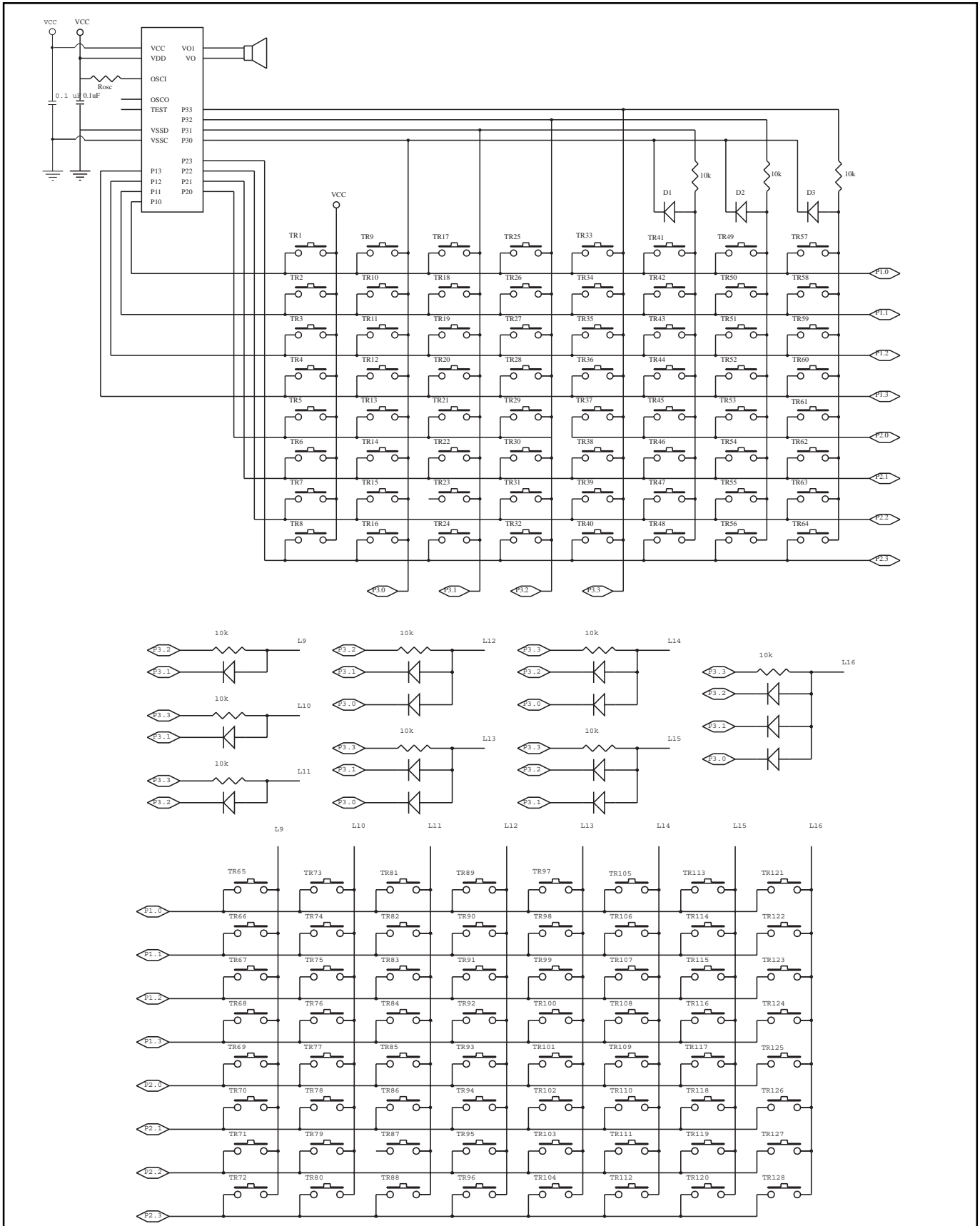

\* This specification is subject to change without further notice.

**PAD DIAGRAM (EM55001)**

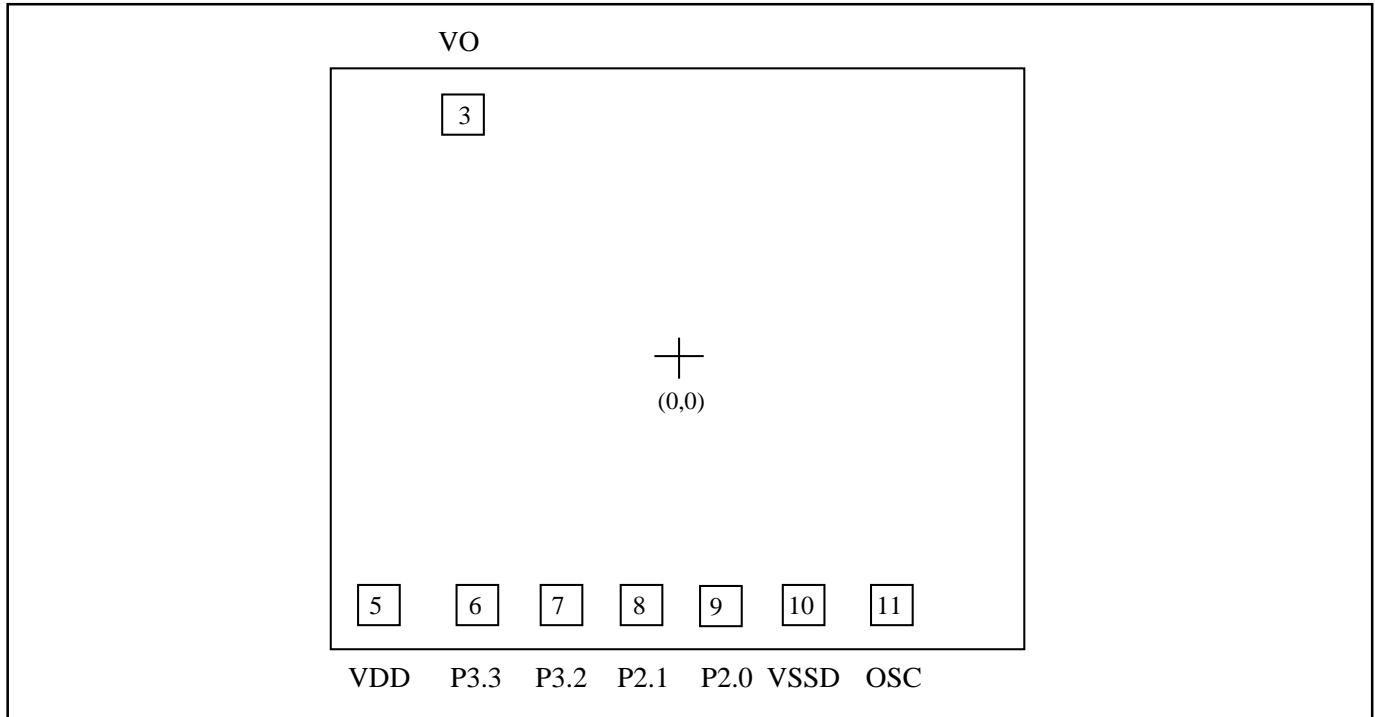

Chip Size : 1250 x 1150 um

For PCB layout, IC substrate must be connected to Vss.

Note : VO should be connected to VSS when not in use.

Pad No.	Symbol	X	Y
1	NC		
2	NC		
3	VO	-320.3	410.0
4	NC		
5	VDD	-468.9	-383.4
6	P3.3	-322.9	-383.4
7	P3.2	-201.5	-383.4
8	P2.1	-78.6	-383.4
9	P2.0	46.1	-383.4
10	VSSD	179.9	-383.4
11	OSCI	325.9	-381.8
12	NC		
13	NC		
14	NC		
15	NC		
16	NC		



**PAD DIAGRAM (EM55002)**

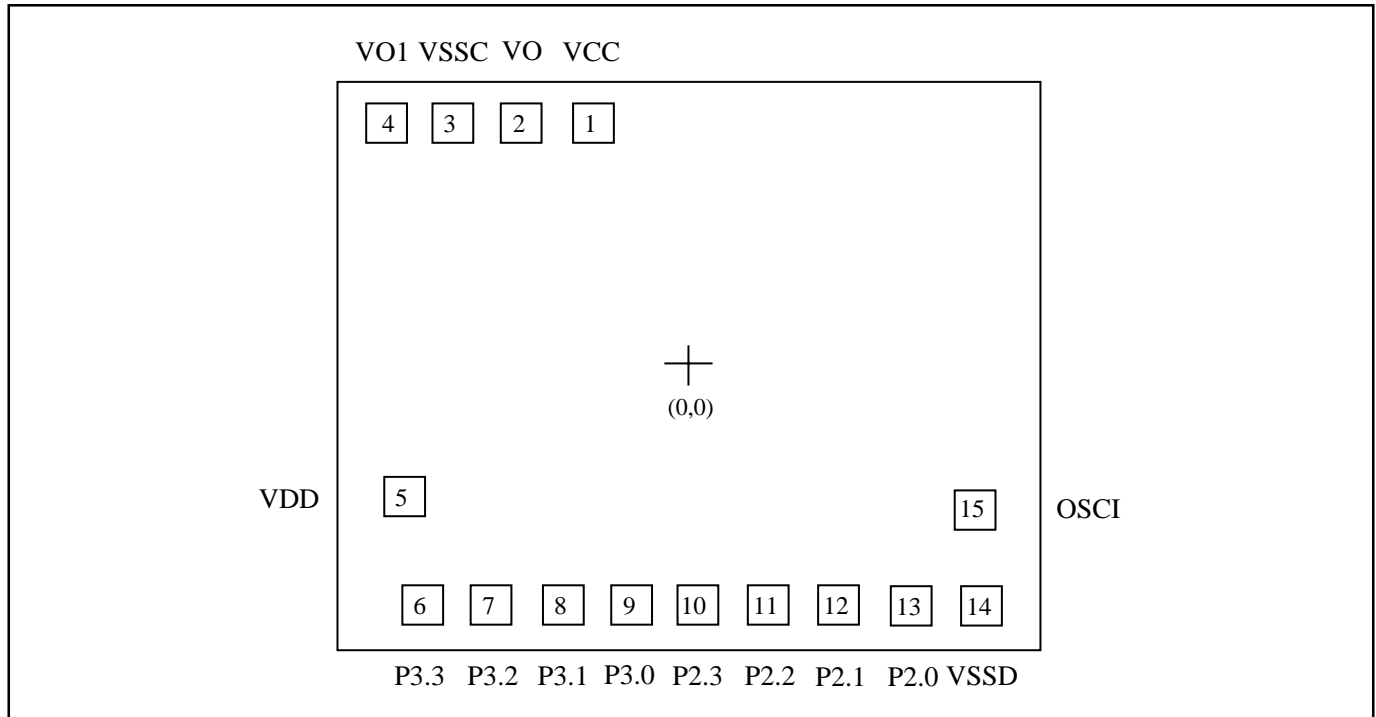

Chip Size : 1400 x 1250 um

For PCB layout, IC substrate must be connected to Vss.

Note : VO should be connected to VDD when not in use.

Pad No.	Symbol	X	Y
1	VCC	-186.9	448.0
2	VO	-306.9	448.0
3	VSSC	-426.9	448.0
4	VO1	-546.9	448.0
5	VDD	-528.4	-227.8
6	P3.3	-476.0	-443.4
7	P3.2	-352.6	-443.4
8	P3.1	-229.2	-443.4
9	P3.0	-105.8	-443.4
10	P2.3	19.1	-443.4
11	P2.2	145.8	-443.4
12	P2.1	272.5	-443.4
13	P2.0	399.2	-443.4
14	VSSD	536.0	-443.4
15	OSCI	526.8	-250.2
16	NC		
17	NC		
18	NC		

**PAD DIAGRAM (EM55100)**

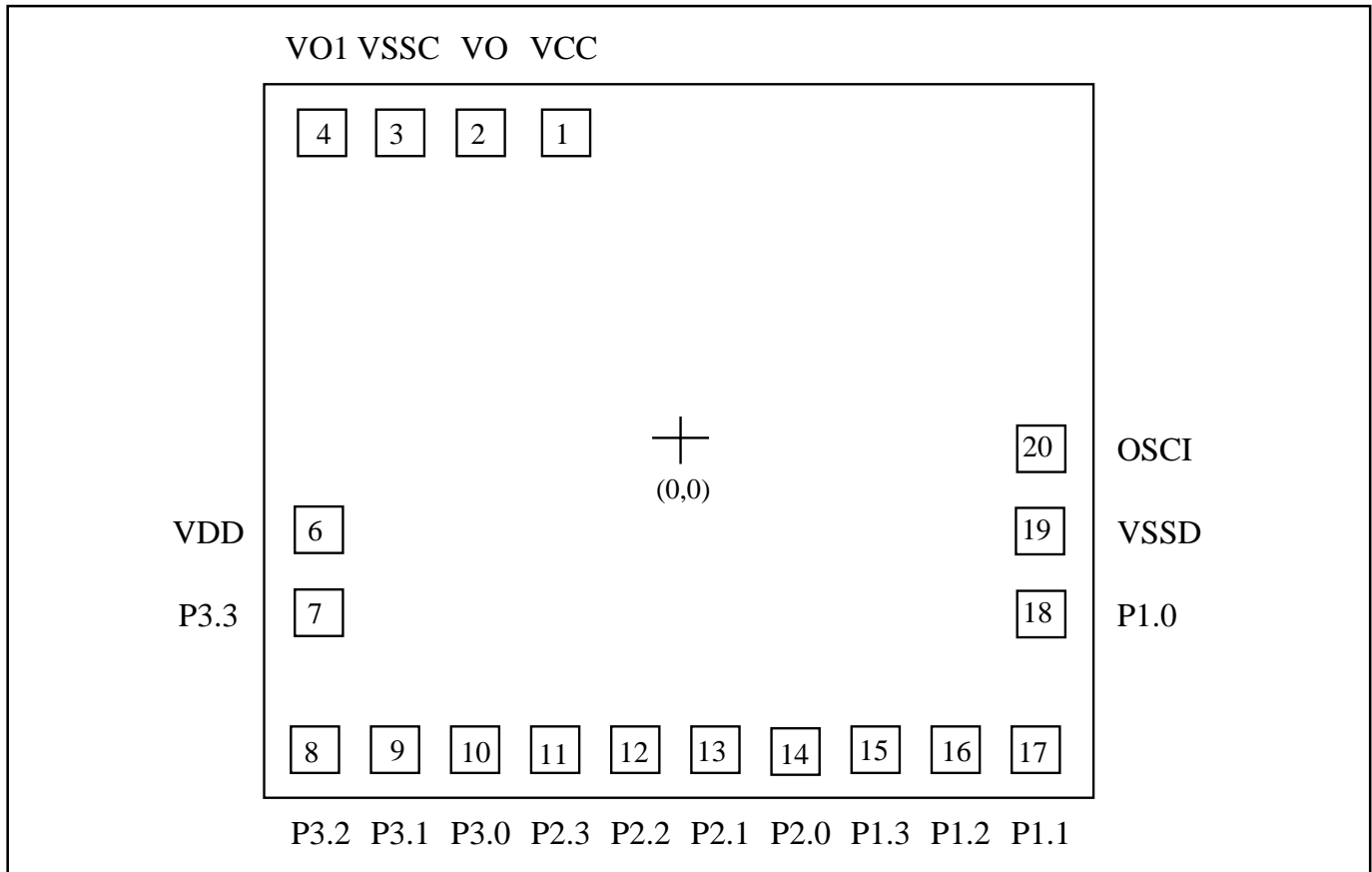

Chip Size : 1400 x 1250 um

For PCB layout, IC substrate must be connected to Vss.

Note : VO should be connected to VDD when not in use.

Pad No.	Symbol	X	Y
1	VCC	-207.8	507.9
2	VO	-327.8	507.9
3	VSSC	-447.8	507.9
4	VO1	-567.8	507.9
5	NC		
6	VDD	-543.4	-168.8
7	P3.3	-543.4	-314.8
8	P3.2	-560.8	-503.4
9	P3.1	-439.4	-503.4
10	P3.0	-318.0	-503.4
11	P2.3	-195.1	-503.4
12	P2.2	-70.4	-503.4

Pad No.	Symbol	X	Y
13	P2.1	54.3	-503.4
14	P2.0	179.0	-503.4
15	P1.3	303.6	-503.4
16	P1.2	426.4	-503.4
17	P1.1	549.0	-503.4
18	P1.0	543.4	-314.4
19	VSSD	543.4	-182.7
20	OSCI	541.8	-36.7
21	NC		
22	NC		
23	NC		
24	NC		

### PAD DIAGRAM (EM55200)

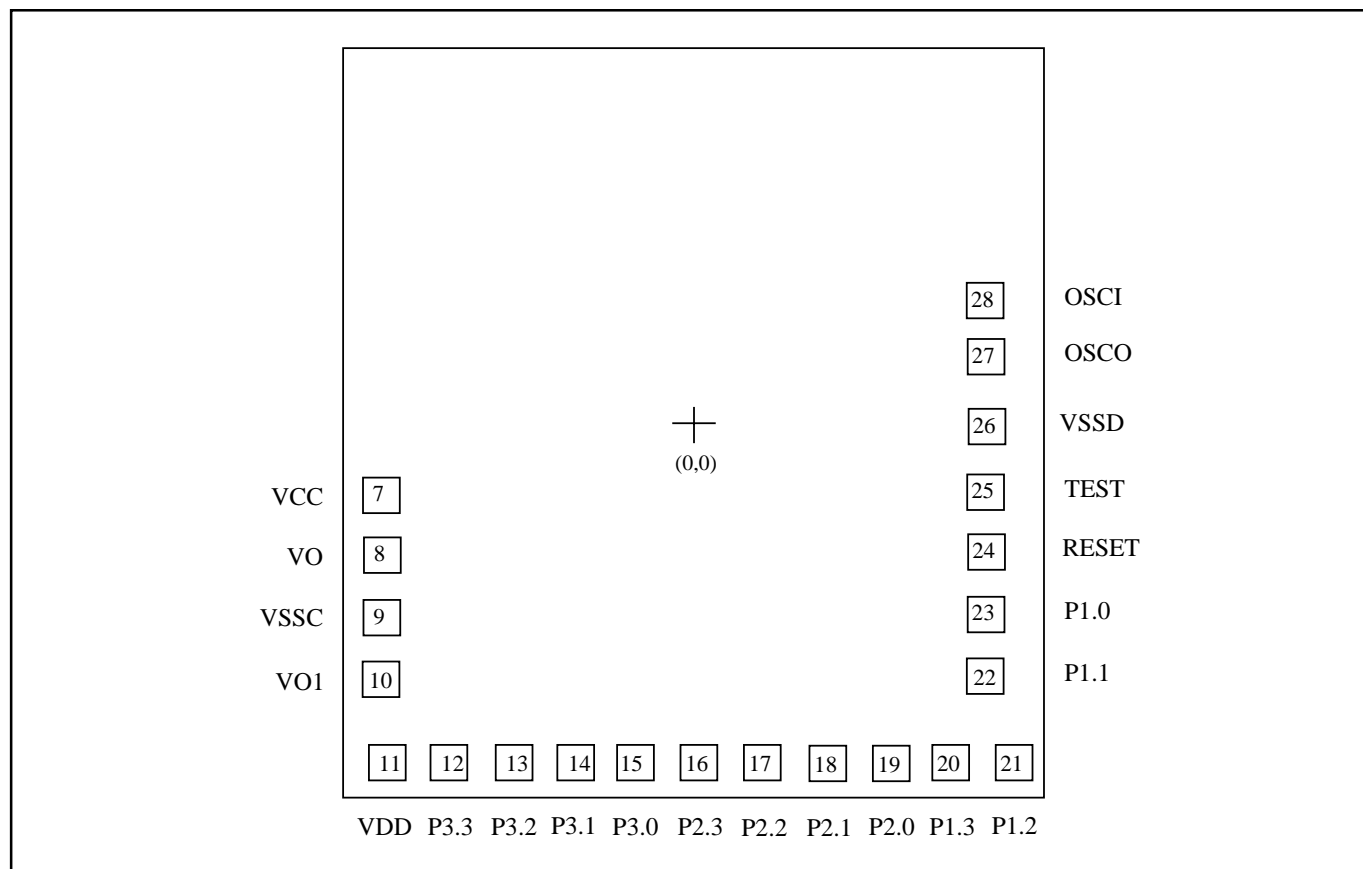

Chip Size : 1600 x 1700 um

For PCB layout, IC substrate must be connected to Vss.

Note : VO should be connected to VSS when not in use.

Pad No.	Symbol	X	Y
1	NC		
2	NC		
3	NC		
4	NC		
5	NC		
6	NC		
7	VCC	-603.0	-85.1
8	VO	-603.0	-205.1
9	VSSC	-603.0	-325.1
10	VO1	-603.0	-445.1
11	VDD	-597.0	-668.4
12	P3.3	-474.9	-668.4
13	P3.2	-353.5	-668.4
14	P3.1	-232.1	-668.4
15	P3.0	-110.7	-668.4
16	P2.3	12.2	-668.4

Pad No.	Symbol	X	Y
17	P2.2	136.9	-668.4
18	P2.1	261.6	-668.4
19	P2.0	386.3	-668.4
20	P1.3	511.0	-668.4
21	P1.2	633.7	-668.4
22	P1.1	598.4	-478.3
23	P1.0	598.4	-355.6
24	RESET	598.4	-232.9
25	TEST	598.4	-110.5
26	VSSD	598.4	21.3
27	OSCO	600.1	187.2
28	OSCI	600.1	309.5
29	NC		
30	NC		
31	NC		
32	NC		

**PAD DIAGRAM (EM55250-XN VERSION)**

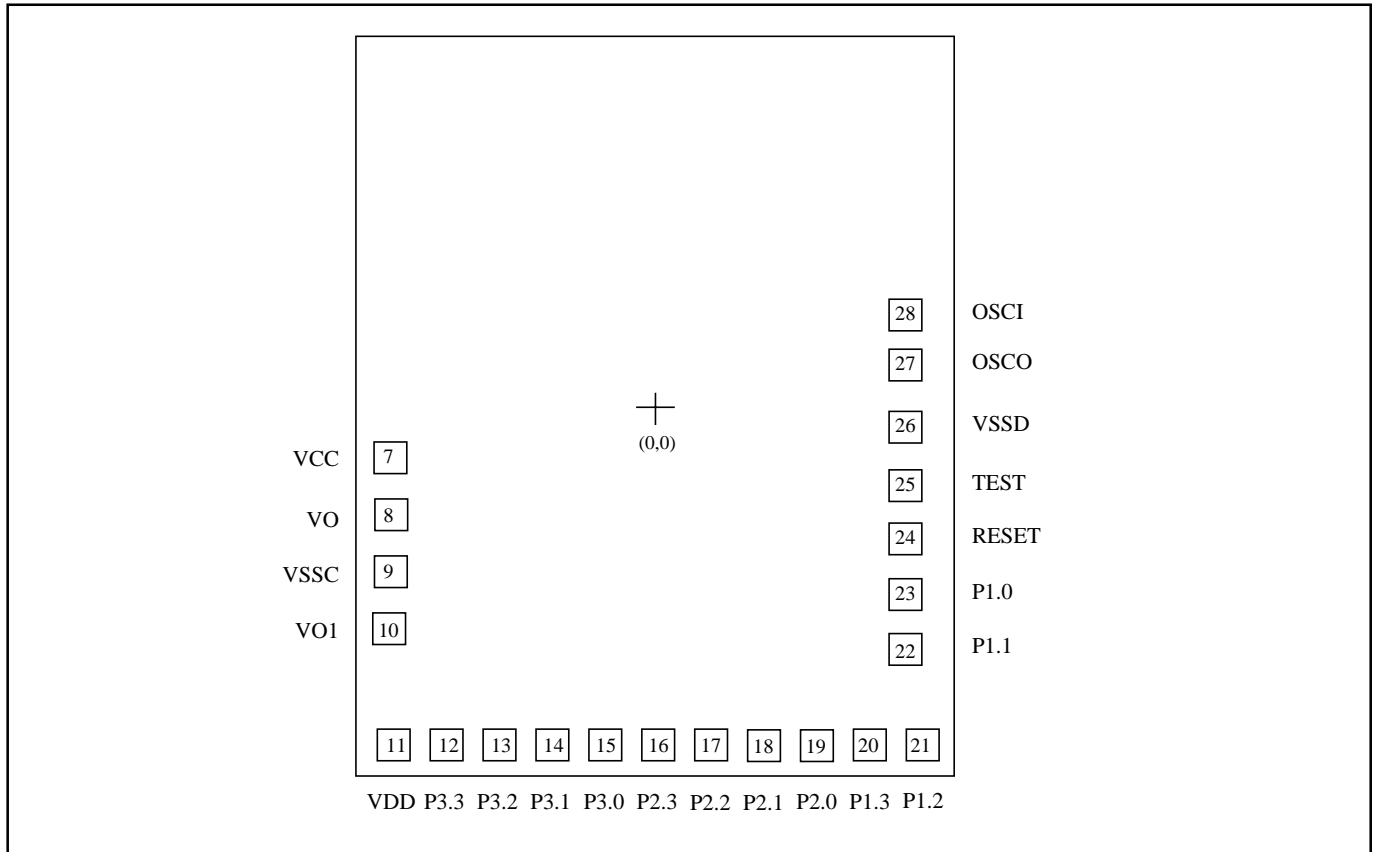

Chip Size : 1540 x 1810 um

For PCB layout, IC substrate must be connected to Vss.

Note : VO should be connected to VSS when not in use.

Pad No.	Symbol	X	Y
1	NC		
2	NC		
3	NC		
4	NC		
5	NC		
6	NC		
7	VCC	-603.0	-150.1
8	VO	-603.0	-270.1
9	VSSC	-603.0	-390.1
10	VO1	-603.0	-510.1
11	VDD	-597.0	-733.4
12	P3.3	-474.9	-733.4
13	P3.2	-353.5	-733.4
14	P3.1	-232.1	-733.4
15	P3.0	-110.7	-733.4
16	P2.3	12.2	-733.4

Pad No.	Symbol	X	Y
17	P2.2	136.9	-733.4
18	P2.1	261.6	-733.4
19	P2.0	386.3	-733.4
20	P1.3	510.7	-733.4
21	P1.2	633.7	-733.4
22	P1.1	598.4	-543.3
23	P1.0	598.4	-420.6
24	RESET	598.4	-297.9
25	TEST	598.4	-175.5
26	VSSD	598.4	-43.7
27	OSCO	600.1	122.1
28	OSCI	600.1	244.4
29	NC		
30	NC		
31	NC		
32	NC		

\* This specification is subject to change without further notice.

### PAD DIAGRAM (EM55250)

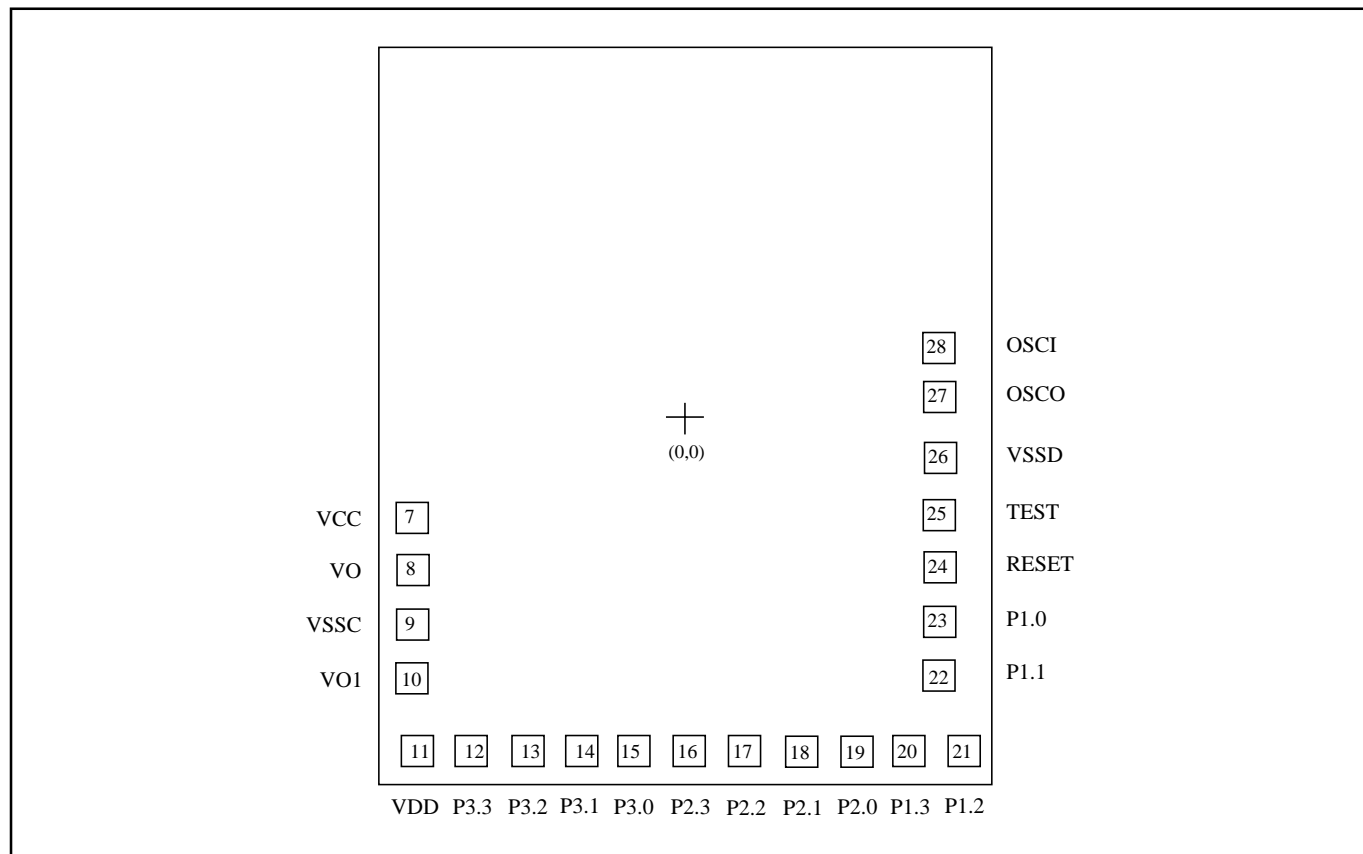

Chip Size : 1600 x 2000 um

For PCB layout, IC substrate must be connected to Vss.

Note : VO should be connected to VSS when not in use.

Pad No.	Symbol	X	Y
1	NC		
2	NC		
3	NC		
4	NC		
5	NC		
6	NC		
7	VCC	-603.0	-215.1
8	VO	-603.0	-335.1
9	VSSC	-603.0	-455.1
10	VOI	-603.0	-575.1
11	VDD	-597.0	-798.4
12	P3.3	-474.9	-798.4
13	P3.2	-353.5	-798.4
14	P3.1	-232.1	-798.4
15	P3.0	-110.7	-798.4
16	P2.3	12.2	-798.4

Pad No.	Symbol	X	Y
17	P2.2	136.9	-798.4
18	P2.1	261.6	-798.4
19	P2.0	386.3	-798.4
20	P1.3	511.0	-798.4
21	P1.2	633.7	-798.4
22	P1.1	598.4	-608.3
23	P1.0	598.4	-485.6
24	RESET	598.4	-362.9
25	TEST	598.4	-240.5
26	VSSD	598.4	-108.7
27	OSCO	600.1	57.2
28	OSCI	600.1	179.5
29	NC		
30	NC		
31	NC		
32	NC		

**PAD DIAGRAM (EM55300)**

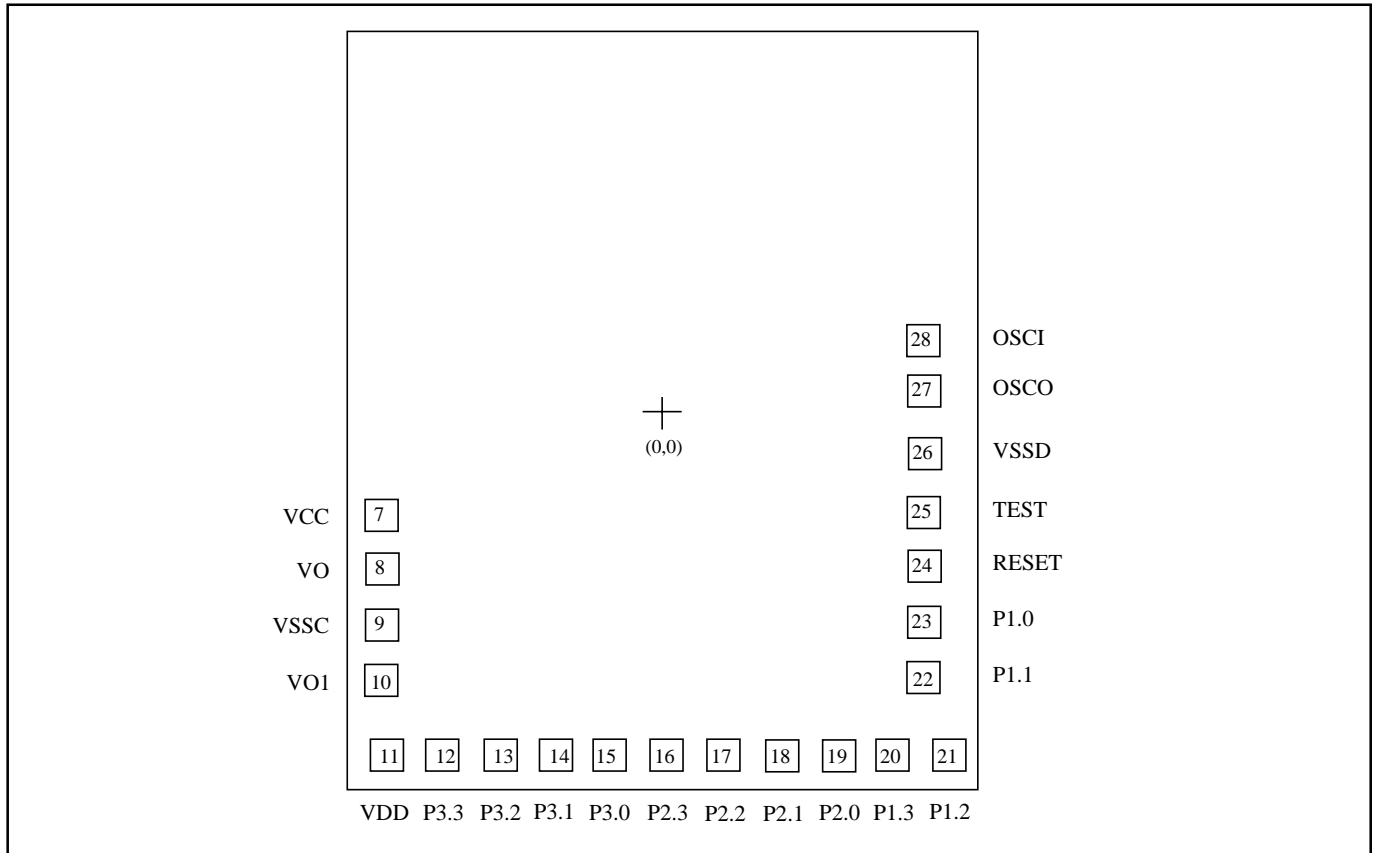

Chip Size : 1600 x 2000 um

For PCB layout, IC substrate must be connected to Vss.

Note : VO should be connected to VSS when not in use.

Pad No.	Symbol	X	Y
1	NC		
2	NC		
3	NC		
4	NC		
5	NC		
6	NC		
7	VCC	-603.0	-215.1
8	VO	-603.0	-335.1
9	VSSC	-603.0	-455.1
10	VO1	-603.0	-575.1
11	VDD	-597.0	-798.4
12	P3.3	-474.9	-798.4
13	P3.2	-353.5	-798.4
14	P3.1	-232.1	-798.4
15	P3.0	-110.7	-798.4
16	P2.3	12.2	-798.4

Pad No.	Symbol	X	Y
17	P2.2	136.9	-798.4
18	P2.1	261.6	-798.4
19	P2.0	386.3	-798.4
20	P1.3	511.0	-798.4
21	P1.2	633.7	-798.4
22	P1.1	598.4	-608.3
23	P1.0	598.4	-485.6
24	RESET	598.4	-362.9
25	TEST	598.4	-240.5
26	VSSD	598.4	-108.7
27	OSCO	600.1	57.2
28	OSCI	600.1	179.5
29	NC		
30	NC		
31	NC		
32	NC		

\* This specification is subject to change without further notice.

**PAD DIAGRAM (EM55350-XP VERSION)**

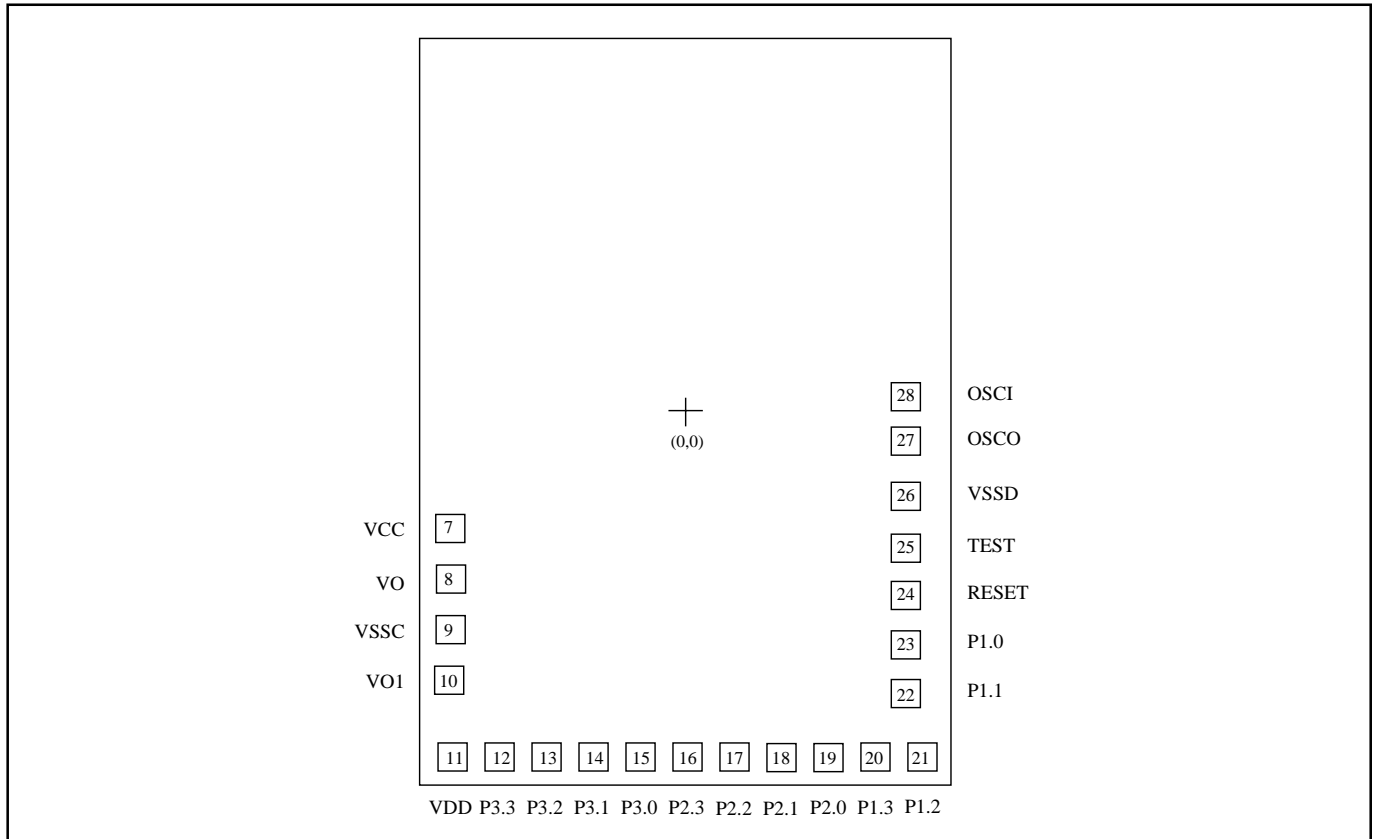

Chip Size : 1540 x 2200 um

For PCB layout, IC substrate must be connected to Vss.

Note : VO should be connected to VSS when not in use.

Pad No.	Symbol	X	Y
1	NC		
2	NC		
3	NC		
4	NC		
5	NC		
6	NC		
7	VCC	-603.0	-345.1
8	VO	-603.0	-465.1
9	VSSC	-603.0	-585.1
10	VO1	-603.0	-705.1
11	VDD	-597.0	-928.4
12	P3.3	-474.9	-928.4
13	P3.2	-353.5	-928.4
14	P3.1	-232.1	-928.4
15	P3.0	-110.7	-928.4
16	P2.3	12.2	-928.4

Pad No.	Symbol	X	Y
17	P2.2	136.9	-928.4
18	P2.1	261.6	-928.4
19	P2.0	386.3	-928.4
20	P1.3	510.7	-928.4
21	P1.2	633.7	-928.4
22	P1.1	598.4	-738.3
23	P1.0	598.4	-615.6
24	RESET	598.4	-492.9
25	TEST	598.4	-370.5
26	VSSD	598.4	-238.7
27	OSCO	600.1	-72.8
28	OSCI	600.1	49.5
29	NC		
30	NC		
31	NC		
32	NC		

### PAD DIAGRAM (EM55350)

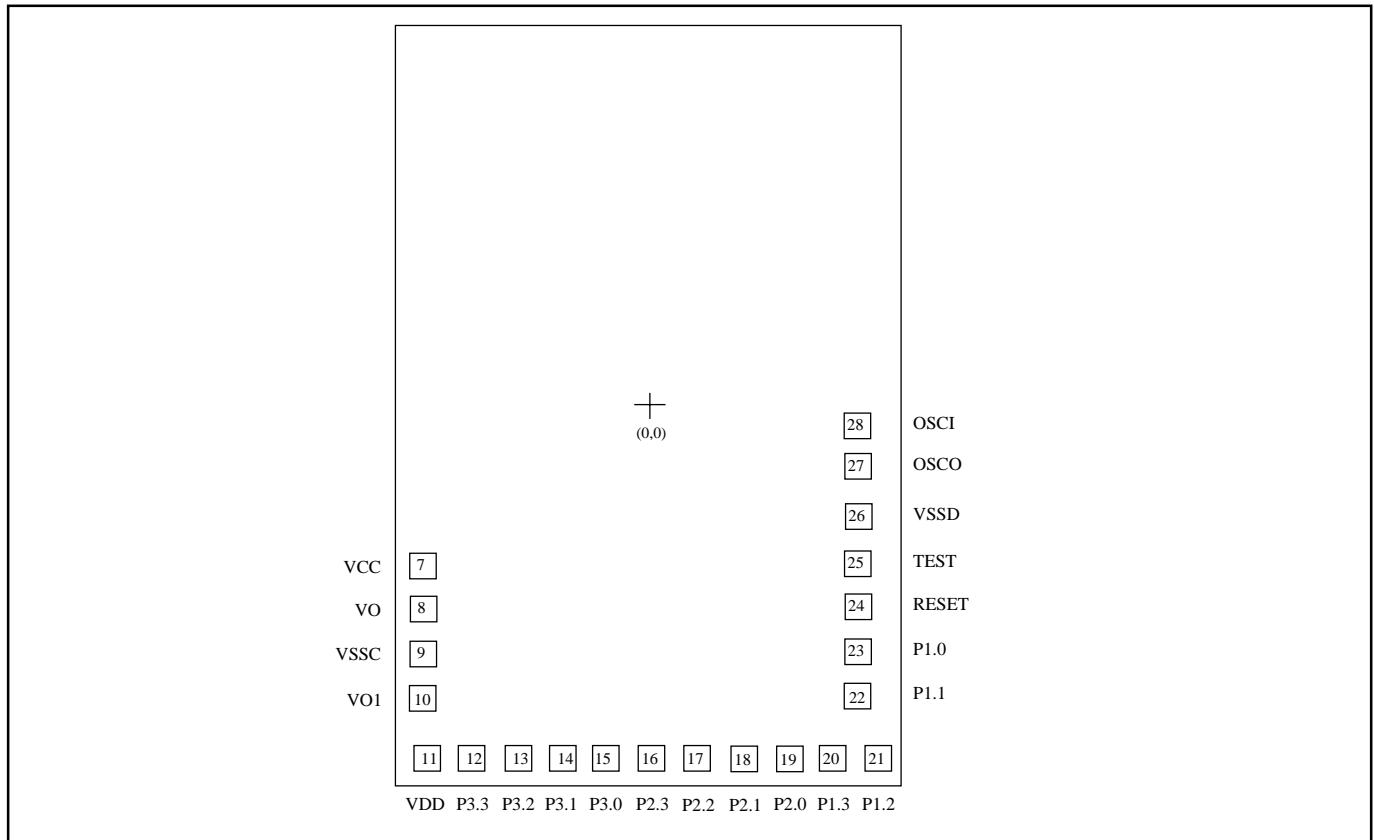

Chip Size : 1600 x 2500 um

For PCB layout, IC substrate must be connected to Vss.

Note : VO should be connected to VSS when not in use.

Pad No.	Symbol	X	Y
1	NC		
2	NC		
3	NC		
4	NC		
5	NC		
6	NC		
7	VCC	-603.0	-480.1
8	VO	-603.0	-600.1
9	VSSC	-603.0	-720.1
10	VO1	-603.0	-840.1
11	VDD	-597.0	-1063.4
12	P3.3	-474.9	-1063.4
13	P3.2	-353.5	-1063.4
14	P3.1	-232.1	-1063.4
15	P3.0	-110.7	-1063.4
16	P2.3	12.2	-1063.4

Pad No.	Symbol	X	Y
17	P2.2	136.9	-1063.4
18	P2.1	261.6	-1063.4
19	P2.0	386.3	-1063.4
20	P1.3	511.0	-1063.4
21	P1.2	633.7	-1063.4
22	P1.1	598.4	-873.3
23	P1.0	598.4	-750.6
24	RESET	598.4	-627.9
25	TEST	598.4	-505.5
26	VSSD	598.4	-373.7
27	OSCO	600.1	-207.9
28	OSCI	600.1	-85.6
29	NC		
30	NC		
31	NC		
32	NC		



### PAD DIAGRAM (EM55400)

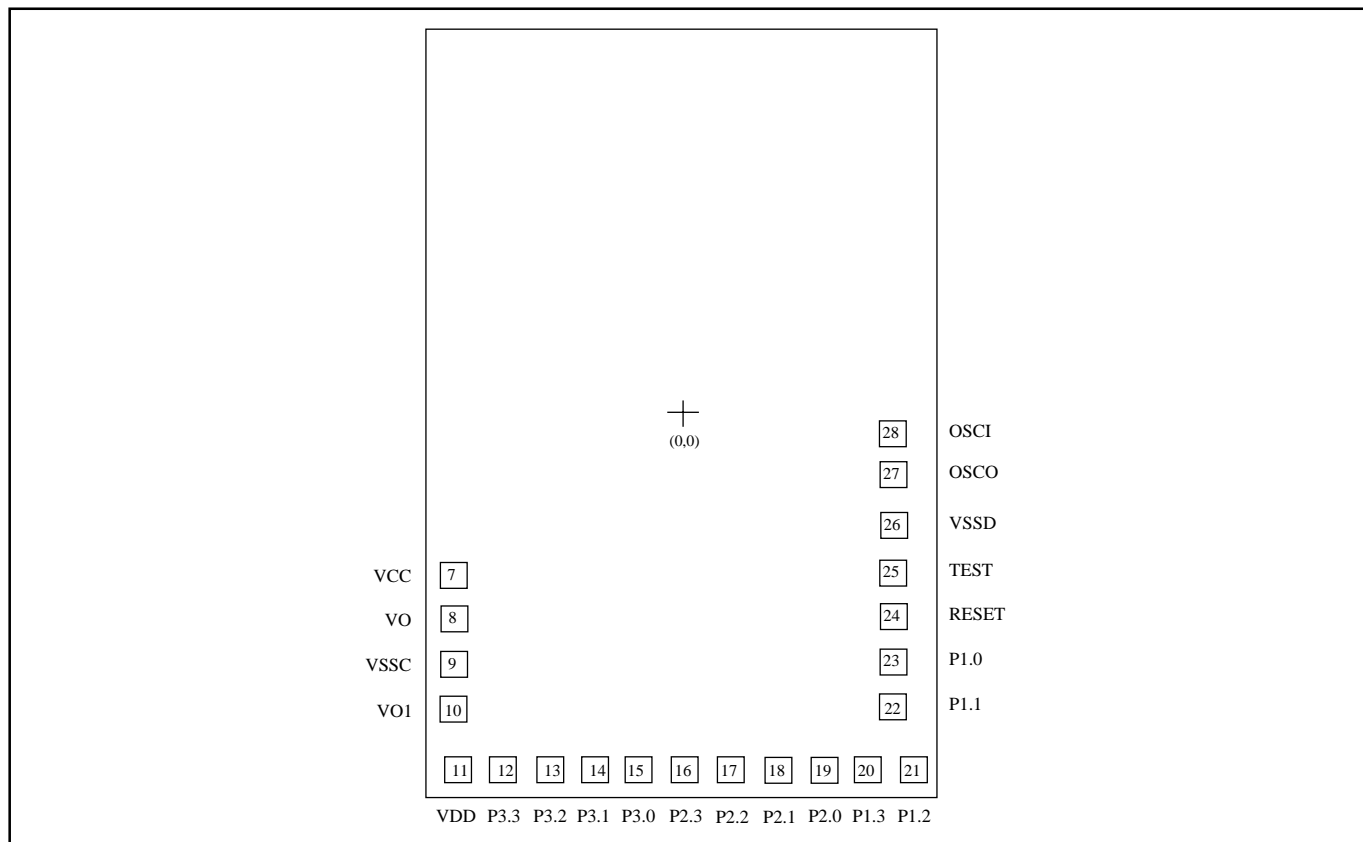

Chip Size : 1600 x 2500 um

For PCB layout, IC substrate must be connected to Vss.

Note : VO should be connected to VSS when not in use.

Pad No.	Symbol	X	Y
1	NC		
2	NC		
3	NC		
4	NC		
5	NC		
6	NC		
7	VCC	-603.0	-480.1
8	VO	-603.0	-600.1
9	VSSC	-603.0	-720.1
10	VO1	-603.0	-840.1
11	VDD	-597.0	-1063.4
12	P3.3	-474.9	-1063.4
13	P3.2	-353.5	-1063.4
14	P3.1	-232.1	-1063.4
15	P3.0	-110.7	-1063.4
16	P2.3	12.2	-1063.4

Pad No.	Symbol	X	Y
17	P2.2	136.9	-1063.4
18	P2.1	261.6	-1063.4
19	P2.0	386.3	-1063.4
20	P1.3	511.0	-1063.4
21	P1.2	633.7	-1063.4
22	P1.1	598.4	-873.3
23	P1.0	598.4	-750.6
24	RESET	598.4	-627.9
25	TEST	598.4	-505.5
26	VSSD	598.4	-373.7
27	OSCO	600.1	-207.9
28	OSCI	600.1	-85.6
29	NC		
30	NC		
31	NC		
32	NC		

\* This specification is subject to change without further notice.

### PAD DIAGRAM (EM55451)

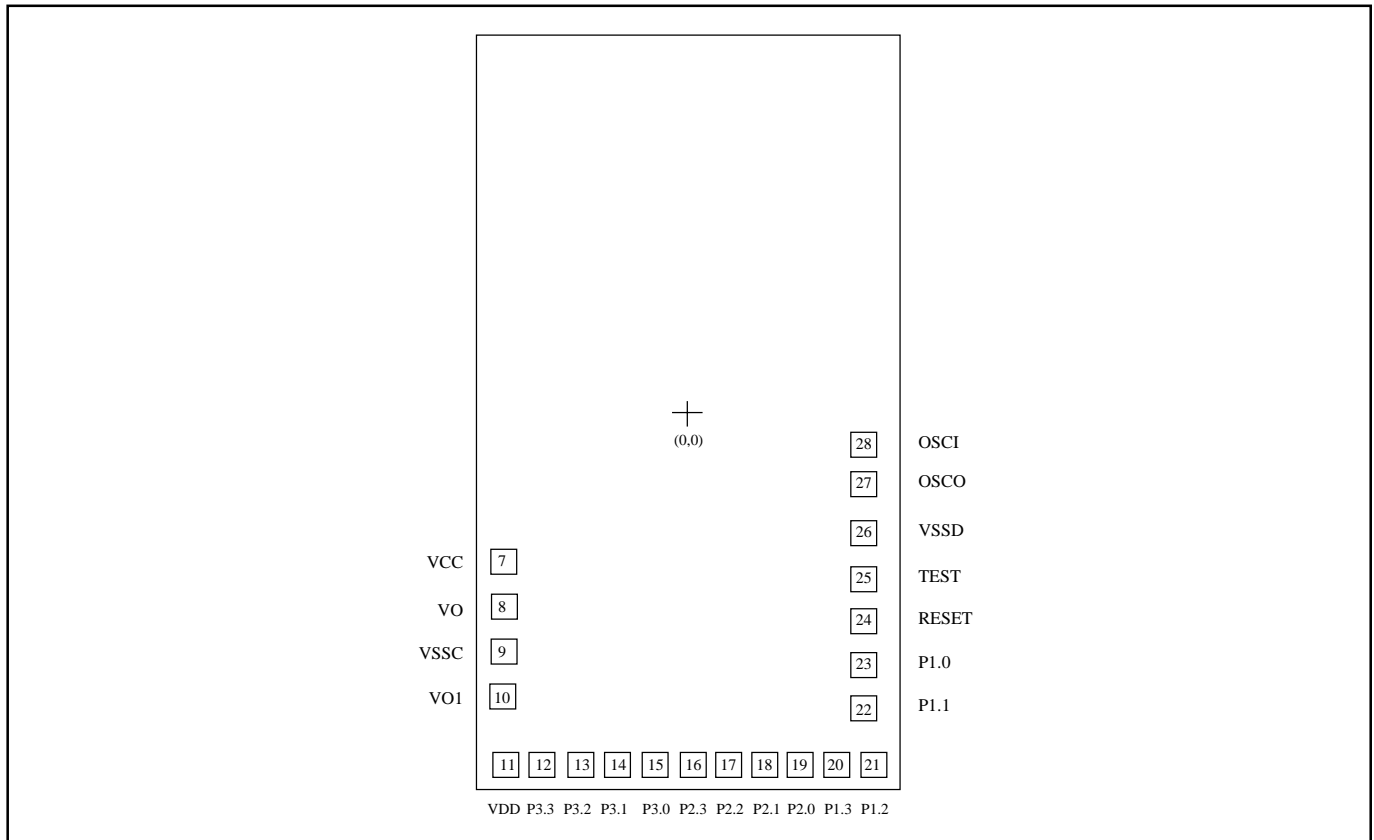

Chip Size : 1510 x 2960 um

For PCB layout, IC substrate must be connected to Vss.

Note : VO should be connected to VSS when not in use.

Pad No.	Symbol	X	Y
1	NC		
2	NC		
3	NC		
4	NC		
5	NC		
6	NC		
7	VCC	-603.0	-740.1
8	VO	-603.0	-860.1
9	VSSC	-603.0	-980.1
10	VO1	-603.0	-1100.1
11	VDD	-597.0	-1323.4
12	P3.3	-474.9	-1323.4
13	P3.2	-353.5	-1323.4
14	P3.1	-232.1	-1323.4
15	P3.0	-110.7	-1323.4
16	P2.3	12.2	-1323.4

Pad No.	Symbol	X	Y
17	P2.2	136.9	-1323.4
18	P2.1	261.6	-1323.4
19	P2.0	386.3	-1323.4
20	P1.3	510.7	-1323.4
21	P1.2	633.7	-1323.4
22	P1.1	598.4	-1133.3
23	P1.0	598.4	-1010.6
24	RESET	598.4	-887.9
25	TEST	598.4	-765.5
26	VSSD	598.4	-633.7
27	OSCO	600.1	-467.8
28	OSCI	600.1	-345.5
29	NC		
30	NC		
31	NC		
32	NC		

**PAD DIAGRAM (EM55450)**

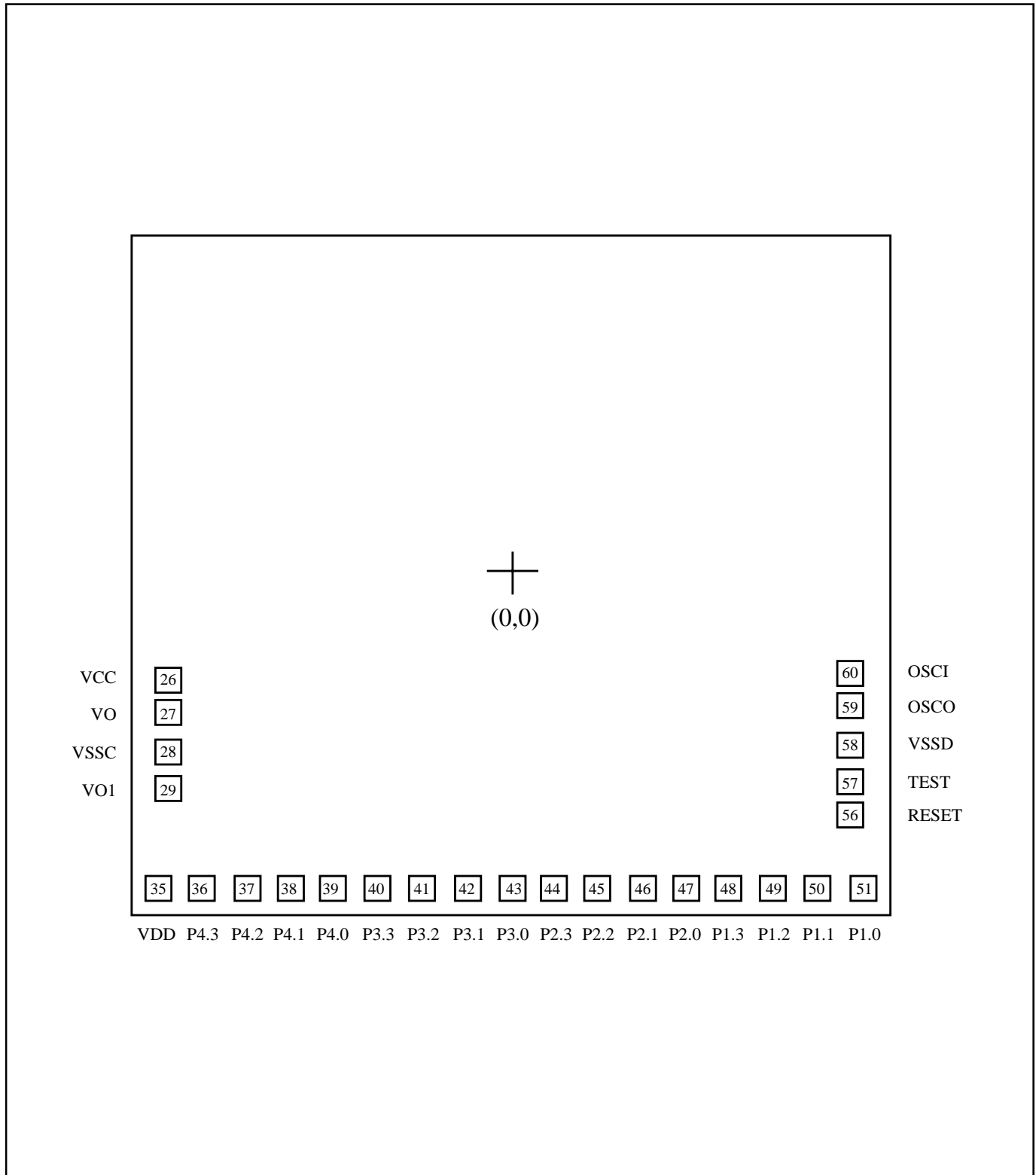

Chip Size : 2300 x 2020 um

For PCB layout, IC substrate must be connected to Vss.

Note : VO should be connected to VSS when not in use.



Pad No.	Symbol	X	Y
1	NC		
2	NC		
3	NC		
4	NC		
5	NC		
6	NC		
7	NC		
8	NC		
9	NC		
10	NC		
11	NC		
12	NC		
13	NC		
14	NC		
15	NC		
16	NC		
17	NC		
18	NC		
19	NC		
20	NC		
21	NC		
22	NC		
23	NC		
24	NC		
25	NC		
26	VCC	-950.9	-165.8
27	VO	-950.9	-285.8
28	VSSC	-950.9	-405.8
29	VO1	-950.9	-525.8
30	NC		
31	NC		
32	NC		
33	NC		
34	NC		
35	VDD	-1000.8	-828.4
36	P4.3	-854.8	-828.4
37	P4.2	-733.4	-828.4
38	P4.1	-612.0	-828.4
39	P4.0	-490.6	-828.4
40	P3.3	-369.2	-828.4

Pad No.	Symbol	X	Y
41	P3.2	-247.8	-828.4
42	P3.1	-126.4	-828.4
43	P3.0	-5.0	-828.4
44	P2.3	117.9	-828.4
45	P2.2	242.5	-828.4
46	P2.1	367.3	-828.4
47	P2.0	492.0	-828.4
48	P1.3	616.3	-828.4
49	P1.2	739.1	-828.4
50	P1.1	861.8	-828.4
51	P1.0	984.7	-828.4
52	NC		
53	NC		
54	NC		
55	NC		
56	RESET	966.0	-613.1
57	TEST	966.0	-491.7
58	VSSD	966.0	-359.9
59	OSCO	967.7	-211.1
60	OSCI	967.7	-88.8
61	NC		
62	NC		
63	NC		
64	NC		
65	NC		
66	NC		
67	NC		
68	NC		
69	NC		
70	NC		
71	NC		
72	NC		
73	NC		
74	NC		
75	NC		
76	NC		
77	NC		
78	NC		
79	NC		
80	NC		

\* This specification is subject to change without further notice.

**PAD DIAGRAM (EM55500)**

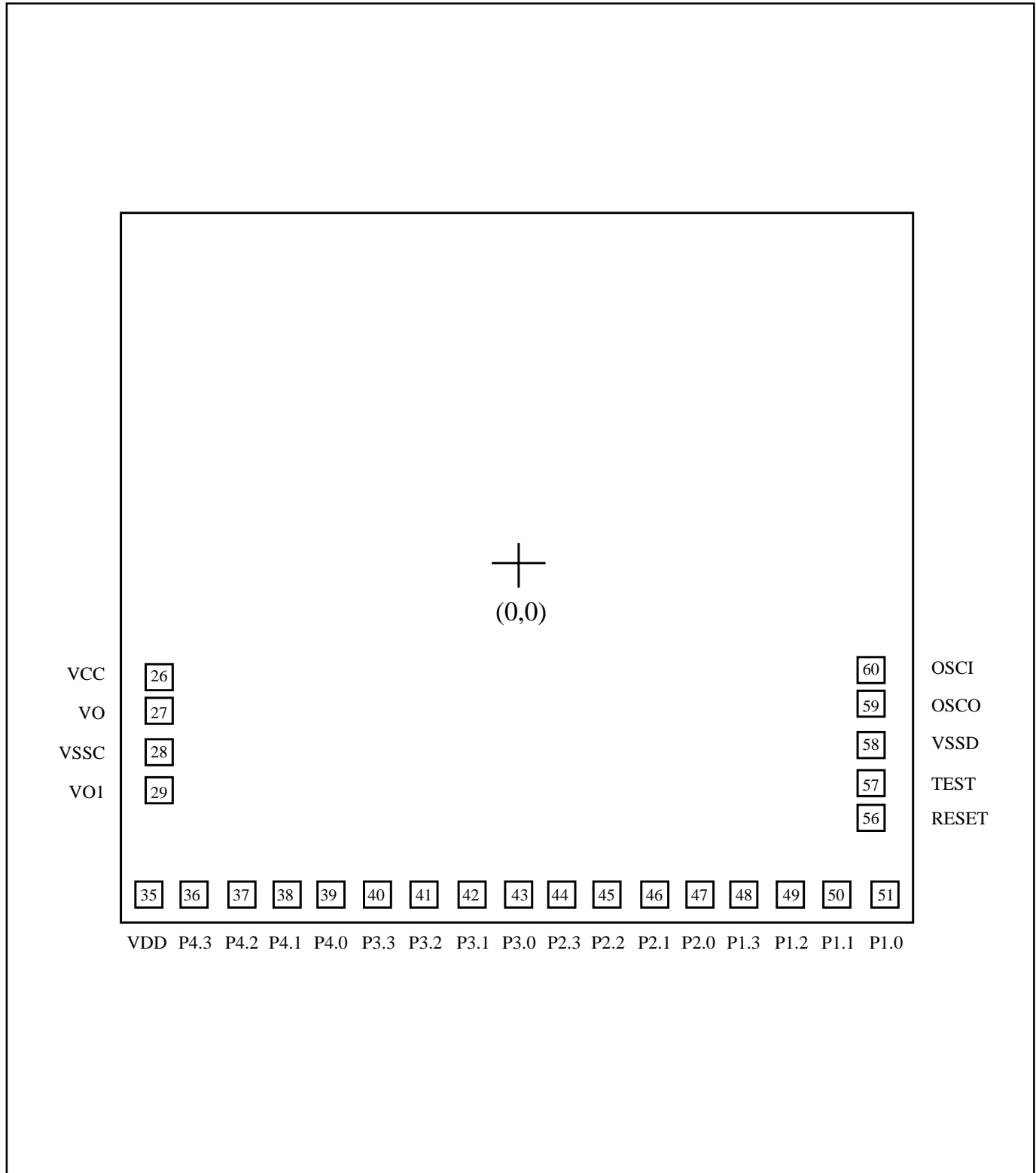

Chip Size : 2300 x 2020 um

For PCB layout, IC substrate must be connected to Vss.

Note : VO should be connected to VSS when not in use.

Pad No.	Symbol	X	Y
1	NC		
2	NC		
3	NC		
4	NC		
5	NC		
6	NC		
7	NC		
8	NC		
9	NC		
10	NC		
11	NC		
12	NC		
13	NC		
14	NC		
15	NC		
16	NC		
17	NC		
18	NC		
19	NC		
20	NC		
21	NC		
22	NC		
23	NC		
24	NC		
25	NC		
26	VCC	-950.9	-165.8
27	VO	-950.9	-285.8
28	VSSC	-950.9	-405.8
29	VO1	-950.9	-525.8
30	NC		
31	NC		
32	NC		
33	NC		
34	NC		
35	VDD	-1000.8	-828.4
36	P4.3	-854.8	-828.4
37	P4.2	-733.4	-828.4
38	P4.1	-612.0	-828.4
39	P4.0	-490.6	-828.4
40	P3.3	-369.2	-828.4

Pad No.	Symbol	X	Y
41	P3.2	-247.8	-828.4
42	P3.1	-126.4	-828.4
43	P3.0	-5.0	-828.4
44	P2.3	117.9	-828.4
45	P2.2	242.5	-828.4
46	P2.1	367.3	-828.4
47	P2.0	492.0	-828.4
48	P1.3	616.3	-828.4
49	P1.2	739.1	-828.4
50	P1.1	861.8	-828.4
51	P1.0	984.7	-828.4
52	NC		
53	NC		
54	NC		
55	NC		
56	RESET	966.0	-613.1
57	TEST	966.0	-491.7
58	VSSD	966.0	-359.9
59	OSCO	967.7	-211.1
60	OSCI	967.7	-88.8
61	NC		
62	NC		
63	NC		
64	NC		
65	NC		
66	NC		
67	NC		
68	NC		
69	NC		
70	NC		
71	NC		
72	NC		
73	NC		
74	NC		
75	NC		
76	NC		
77	NC		
78	NC		
79	NC		
80	NC		

\* This specification is subject to change without further notice.

### PAD DIAGRAM (EM55551)

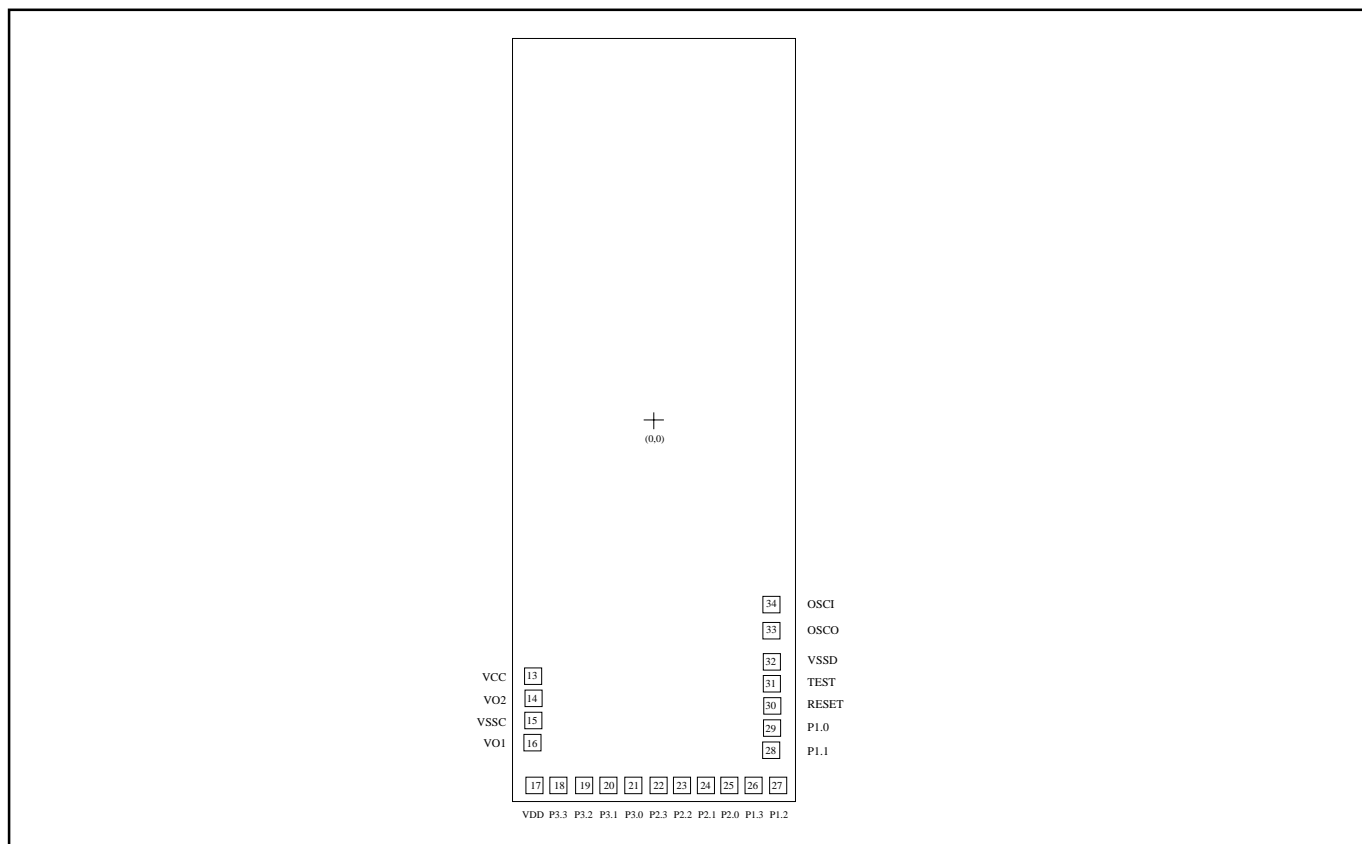

Chip Size : 1510 x 4530 um

For PCB layout, IC substrate must be connected to Vss.

Note : VO should be connected to VSS when not in use.

Pad No.	Symbol	X	Y
1	NC		
2	NC		
3	NC		
4	NC		
5	NC		
6	NC		
7	NC		
8	NC		
9	NC		
10	NC		
11	NC		
12	NC		
13	VCC	-603.0	-1525.1
14	VO2	-603.0	-1645.1
15	VSSC	-603.0	-1765.1
16	VO1	-603.0	-1885.1
17	VDD	-597.0	-2108.4

Pad No.	Symbol	X	Y
18	P3.3	-474.9	-2108.4
19	P3.2	-353.5	-2108.4
20	P3.1	-232.1	-2108.4
21	P3.0	-110.7	-2108.4
22	P2.3	12.2	-2108.4
23	P2.2	136.9	-2108.4
24	P2.1	261.6	-2108.4
25	P2.0	386.3	-2108.4
26	P1.3	510.7	-2108.4
27	P1.2	633.7	-2108.4
28	P1.1	598.4	-1918.3
29	P1.0	598.4	-1795.6
30	RESET	598.4	-1672.9
31	TEST	598.4	-1550.5
32	VSSD	598.4	-1418.7
33	OSCO	600.1	-1252.9
34	OSCI	600.1	-1130.6

**PAD DIAGRAM (EM55600)**

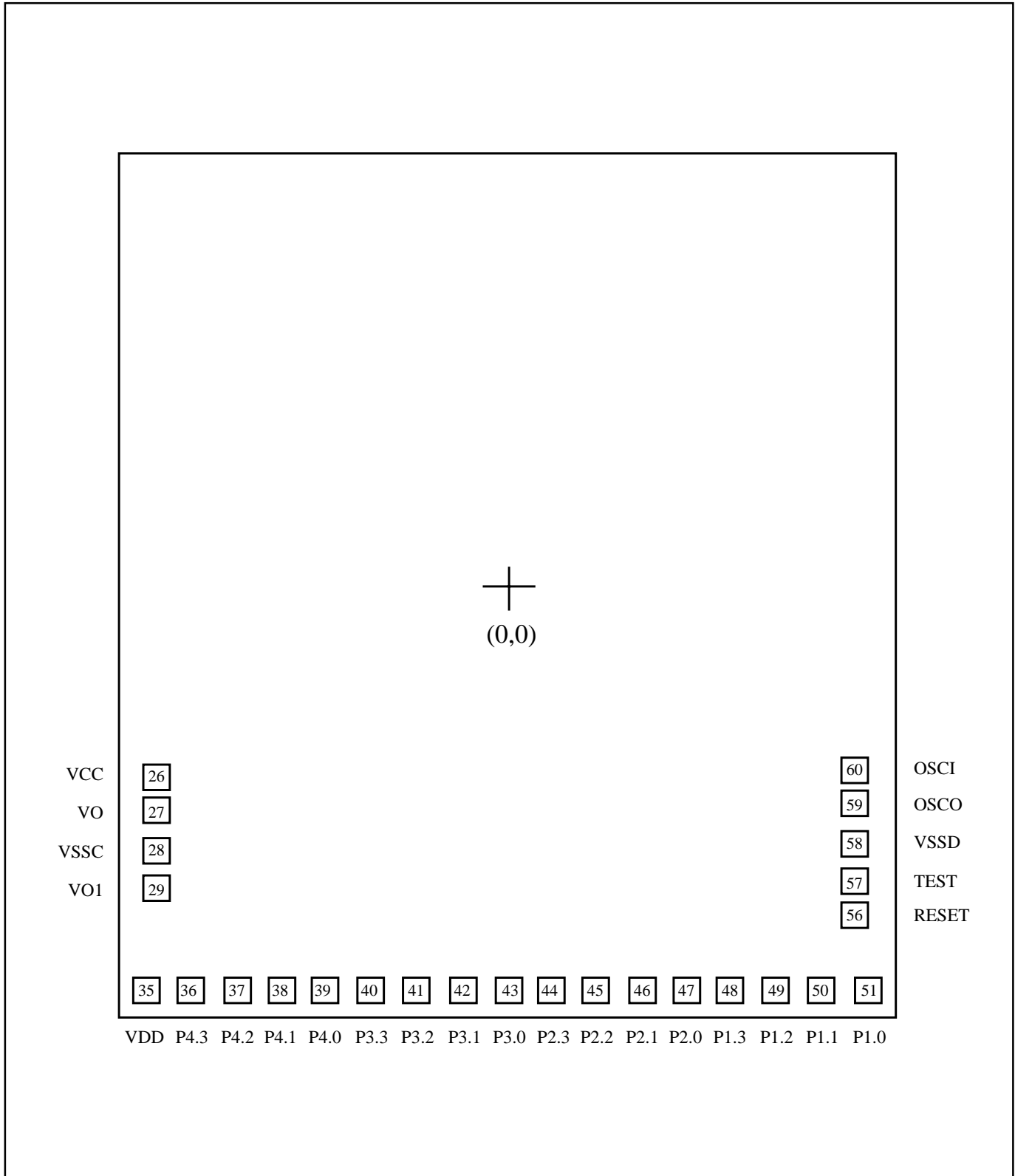

Chip Size : 2300 x 2820 um

For PCB layout, IC substrate must be connected to Vss.

Note : VO should be connected to VSS when not in use.





Pad No.	Symbol	X	Y
1	NC		
2	NC		
3	NC		
4	NC		
5	NC		
6	NC		
7	NC		
8	NC		
9	NC		
10	NC		
11	NC		
12	NC		
13	NC		
14	NC		
15	NC		
16	NC		
17	NC		
18	NC		
19	NC		
20	NC		
21	NC		
22	NC		
23	NC		
24	NC		
25	NC		
26	VCC	-950.9	-565.8
27	VO	-950.9	-685.8
28	VSSC	-950.9	-805.8
29	VO1	-950.9	-925.8
30	NC		
31	NC		
32	NC		
33	NC		
34	NC		
35	VDD	-1000.8	-1228.4
36	P4.3	-854.8	-1228.4
37	P4.2	-733.4	-1228.4
38	P4.1	-612.0	-1228.4
39	P4.0	-490.6	-1228.4
40	P3.3	-369.2	-1228.4

Pad No.	Symbol	X	Y
41	P3.2	-247.8	-1228.4
42	P3.1	-126.4	-1228.4
43	P3.0	-5.0	-1228.4
44	P2.3	117.9	-1228.4
45	P2.2	242.5	-1228.4
46	P2.1	367.3	-1228.4
47	P2.0	492.0	-1228.4
48	P1.3	616.3	-1228.4
49	P1.2	739.1	-1228.4
50	P1.1	861.8	-1228.4
51	P1.0	984.7	-1228.4
52	NC		
53	NC		
54	NC		
55	NC		
56	RESET	966.0	-1013.1
57	TEST	966.0	-891.7
58	VSSD	966.0	-759.9
59	OSCO	967.7	-611.1
60	OSCI	967.7	-488.8
61	NC		
62	NC		
63	NC		
64	NC		
65	NC		
66	NC		
67	NC		
68	NC		
69	NC		
70	NC		
71	NC		
72	NC		
73	NC		
74	NC		
75	NC		
76	NC		
77	NC		
78	NC		
79	NC		
80	NC		

\* This specification is subject to change without further notice.

**PAD DIAGRAM (EM55650)**

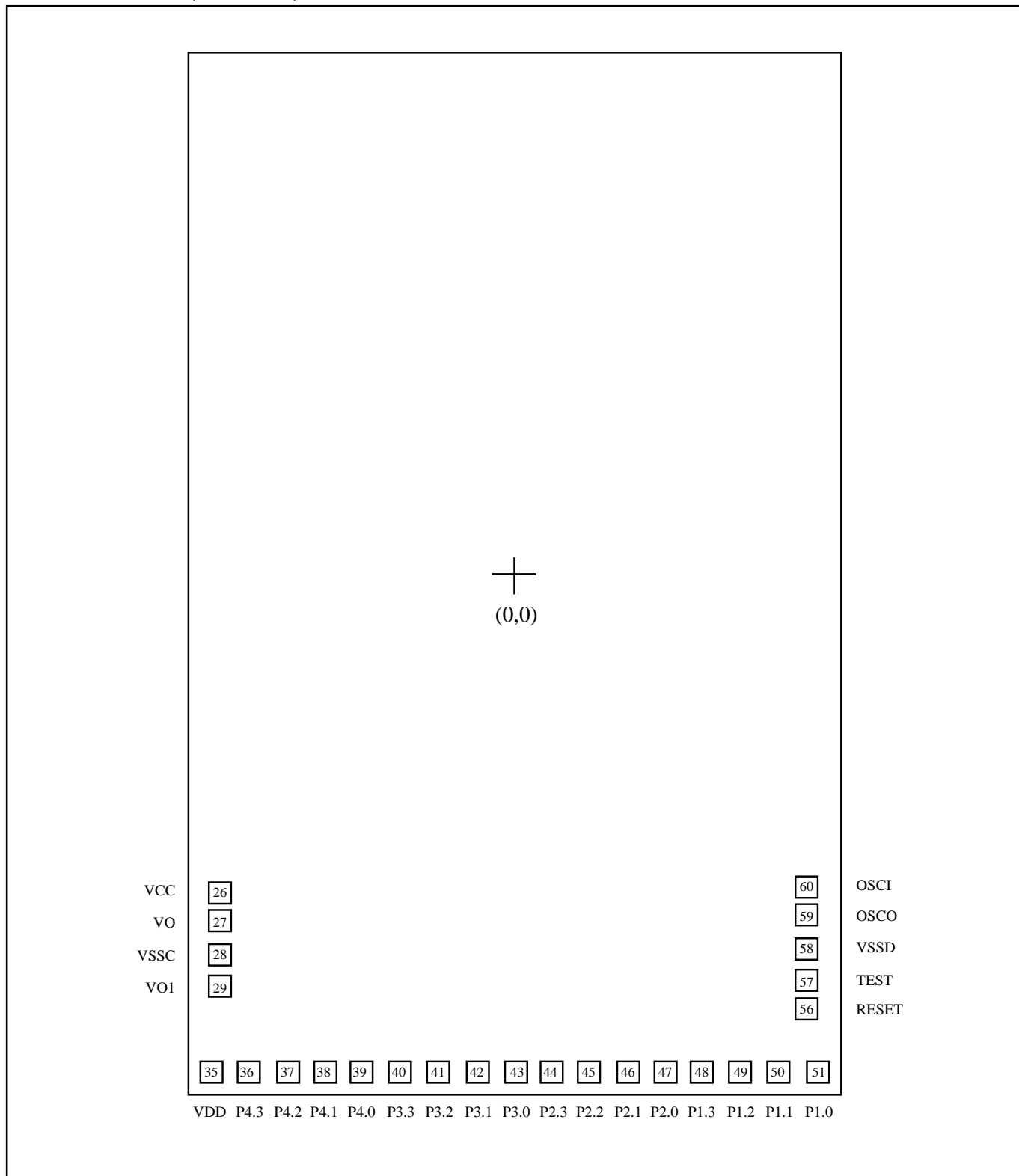

Chip Size : 2300 x 4410 um

For PCB layout, IC substrate must be connected to Vss.

Note : VO should be connected to VSS when not in use.



Pad No.	Symbol	X	Y
1	NC		
2	NC		
3	NC		
4	NC		
5	NC		
6	NC		
7	NC		
8	NC		
9	NC		
10	NC		
11	NC		
12	NC		
13	NC		
14	NC		
15	NC		
16	NC		
17	NC		
18	NC		
19	NC		
20	NC		
21	NC		
22	NC		
23	NC		
24	NC		
25	NC		
26	VCC	-950.9	-1360.8
27	VO	-950.9	-1480.8
28	VSSC	-950.9	-1600.7
29	VO1	-950.9	-1720.8
30	NC		
31	NC		
32	NC		
33	NC		
34	NC		
35	VDD	-1000.8	-2023.4
36	P4.3	-854.8	-2023.4
37	P4.2	-733.4	-2023.4
38	P4.1	-612.0	-2023.4
39	P4.0	-490.6	-2023.4
40	P3.3	-369.2	-2023.4

Pad No.	Symbol	X	Y
41	P3.2	-247.8	-2023.4
42	P3.1	-126.4	-2023.4
43	P3.0	-5.0	-2023.4
44	P2.3	117.9	-2023.4
45	P2.2	242.5	-2023.4
46	P2.1	367.3	-2023.4
47	P2.0	492.0	-2023.4
48	P1.3	616.3	-2023.4
49	P1.2	739.1	-2023.4
50	P1.1	861.8	-2023.4
51	P1.0	984.7	-2023.4
52	NC		
53	NC		
54	NC		
55	NC		
56	RESET	966.0	-1808.1
57	TEST	966.0	-1686.7
58	VSSD	966.0	-1554.9
59	OSCO	967.7	-1406.1
60	OSCI	967.7	-1283.8
61	NC		
62	NC		
63	NC		
64	NC		
65	NC		
66	NC		
67	NC		
68	NC		
69	NC		
70	NC		
71	NC		
72	NC		
73	NC		
74	NC		
75	NC		
76	NC		
77	NC		
78	NC		
79	NC		
80	NC		

\* This specification is subject to change without further notice.

**PAD DIAGRAM (EM55700)**

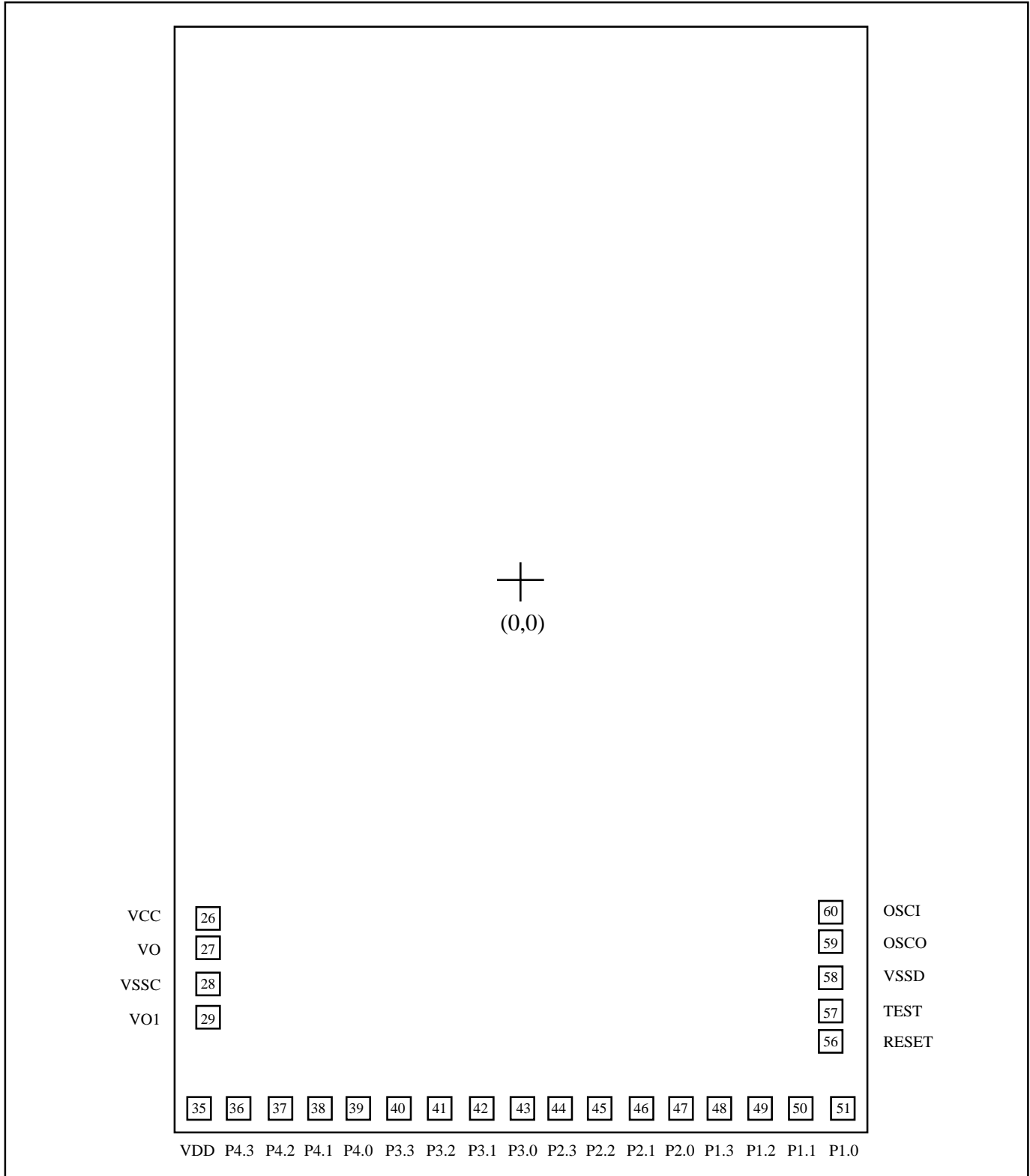

Chip Size : 2300 x 4410 um

For PCB layout, IC substrate must be connected to Vss.

Note : VO should be connected to VSS when not in use.



Pad No.	Symbol	X	Y
1	NC		
2	NC		
3	NC		
4	NC		
5	NC		
6	NC		
7	NC		
8	NC		
9	NC		
10	NC		
11	NC		
12	NC		
13	NC		
14	NC		
15	NC		
16	NC		
17	NC		
18	NC		
19	NC		
20	NC		
21	NC		
22	NC		
23	NC		
24	NC		
25	NC		
26	VCC	-950.9	-1360.8
27	VO	-950.9	-1480.8
28	VSSC	-950.9	-1600.7
29	VO1	-950.9	-1720.8
30	NC		
31	NC		
32	NC		
33	NC		
34	NC		
35	VDD	-1000.8	-2023.4
36	P4.3	-854.8	-2023.4
37	P4.2	-733.4	-2023.4
38	P4.1	-612.0	-2023.4
39	P4.0	-490.6	-2023.4
40	P3.3	-369.2	-2023.4

Pad No.	Symbol	X	Y
41	P3.2	-247.8	-2023.4
42	P3.1	-126.4	-2023.4
43	P3.0	-5.0	-2023.4
44	P2.3	117.9	-2023.4
45	P2.2	242.5	-2023.4
46	P2.1	367.3	-2023.4
47	P2.0	492.0	-2023.4
48	P1.3	616.3	-2023.4
49	P1.2	739.1	-2023.4
50	P1.1	861.8	-2023.4
51	P1.0	984.7	-2023.4
52	NC		
53	NC		
54	NC		
55	NC		
56	RESET	966.0	-1808.1
57	TEST	966.0	-1686.7
58	VSSD	966.0	-1554.9
59	OSCO	967.7	-1406.1
60	OSCI	967.7	-1283.8
61	NC		
62	NC		
63	NC		
64	NC		
65	NC		
66	NC		
67	NC		
68	NC		
69	NC		
70	NC		
71	NC		
72	NC		
73	NC		
74	NC		
75	NC		
76	NC		
77	NC		
78	NC		
79	NC		
80	NC		

\* This specification is subject to change without further notice.